

AVENTICS Series NU2 Fittings with tube nuts

AVENTICS Series NU2, are a complete range of plastic and Brass fittings with tube nuts, Versatile and safe NU2 fittings with nuts benefit of a large selection of connection type.



Technical data

Industry	Industrial
Fitting type	T-Banjo connection
Compressed air connection type	External thread
Port G	G 1/4
Compressed air connection type 2	plug-in with tube nut
Port D	Ø 6
Type	NU2-S-RTS
Min. working pressure	-0.95 bar
Max. working pressure	15 bar
Min. ambient temperature	-10 °C
Max. ambient temperature	70 °C
Delivery unit	5 piece
Weight	0.06 kg

Material

Housing material	Brass
Surface housing	nickel-plated
Seal material	Polyvinyl chloride
Part No.	1823391007

Series NU2

1823391007

2024-04-04

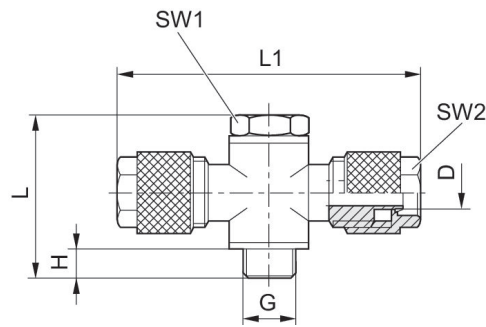

Part No.	Port D	Port G	H	L	L1	SW 1	SW 2
1823391071	Ø 3	M5	3.5	17.5	31	8	8
1823391036	Ø 4	M5	3.5	17.5	31	8	9
1823391070	Ø 3	G 1/8	6.5	28	42	14	8
1823391004	Ø 4	G 1/8	6	28	45	14	10
1823391005	Ø 6	G 1/8	6	28	45	14	12
1823391006	Ø 4	G 1/4	6.5	29.5	49	17	10
1823391007	Ø 6	G 1/4	7	33	49	17	12
1823391033	Ø 6	G 3/8	8	31.5	50	22	12
1823391034	Ø 9	G 3/8	8	31.5	60	22	15

Connection D = inside diameter of the tubing to be used