

AVENTICS Series NU2 Fittings with tube nuts

AVENTICS Series NU2, are a complete range of plastic and Brass fittings with tube nuts, Versatile and safe NU2 fittings with nuts benefit of a large selection of connection type.



Technical data

Industry	Industrial
Fitting type	T-union
Compressed air connection type	External thread
Port G	G 1/8
Compressed air connection type 2	plug-in with tube nut
Port D	Ø 6
Type	NU2-S-RTT
Min. working pressure	-0.95 bar
Max. working pressure	15 bar
Min. ambient temperature	-25 °C
Max. ambient temperature	70 °C
Delivery unit	10 piece
Weight	0.024 kg

Material

Housing material	Brass
Surface housing	nickel-plated
Part No.	1823391781

Series NU2

1823391781

2024-04-04

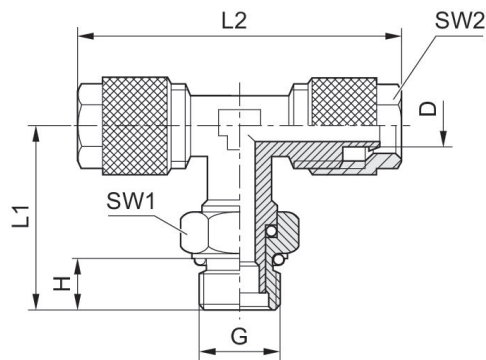

Part No.	Port D	Port G	H	L1	L2	SW1	SW2
1823391779	Ø 4	G 1/8	6	22	40	13	10
1823391781	Ø 6	G 1/8	6	24	40	13	12
1823391780	Ø 4	G 1/4	8	26	40	16	10
1823391782	Ø 6	G 1/4	8	27.5	43	16	12
1823391783	Ø 8	G 1/4	8	27.5	45	16	14

Connection D = inside diameter of the tubing to be used