

AVENTICS Series NU2 Fittings with tube nuts

AVENTICS Series NU2, are a complete range of plastic and Brass fittings with tube nuts, Versatile and safe NU2 fittings with nuts benefit of a large selection of connection type.



Technical data

Industry	Industrial
Fitting type	T-union
Compressed air connection type	External thread
Port G	R 1/4
Compressed air connection type 2	plug-in with tube nut
Port D	Ø 4
Type	NU2-S-RTT
Min. working pressure	-0.95 bar
Max. working pressure	15 bar
Min. ambient temperature	-25 °C
Max. ambient temperature	70 °C
Delivery unit	10 piece
Weight	0.026 kg

Material

Housing material	Brass
Surface housing	nickel-plated
Part No.	1823391791

Technical information

For use up to -40 °C when using with compressed air tubing series TU1-S-PAM Ø4x1, Ø6x1, Ø8x1, Ø10x1, Ø12x1.5

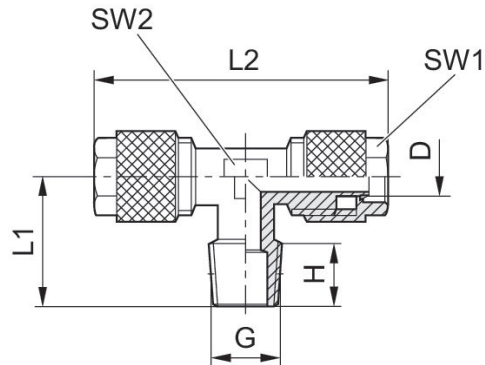

Part No.	Port D	Port G	H	L1	L2	SW 1	SW 2
1823391789	Ø 4	R 1/8	7.3	14.5	36	8	8
1823391790	Ø 6	R 1/8	7.3	16	37	9	9
1823391791	Ø 4	R 1/4	10.5	19	40	9	9
1823391792	Ø 6	R 1/4	11	20	40	9	9
1823391793	Ø 8	R 1/4	10.5	22	41	12	12

Connection D = inside diameter of the tubing to be used