

AVENTICS Series NU2 Fittings with tube nuts

AVENTICS Series NU2, are a complete range of plastic and Brass fittings with tube nuts, Versatile and safe NU2 fittings with nuts benefit of a large selection of connection type.



Technical data

Industry	Industrial
Fitting type	X-connector
Compressed air connection type	plug-in with tube nut
Port G	Ø 3
Compressed air connection type 2	plug-in with tube nut
Port D	Ø 3
Type	NU2-S-RXS
Min. working pressure	-0.95 bar
Max. working pressure	15 bar
Min. ambient temperature	-25 °C
Max. ambient temperature	70 °C
Delivery unit	5 piece

Material

Housing material	Brass
Surface housing	nickel-plated
Part No.	1823391801

Technical information

For use up to -40 °C when using with compressed air tubing series TU1-S-PAM Ø4x1, Ø6x1, Ø8x1, Ø10x1, Ø12x1.5

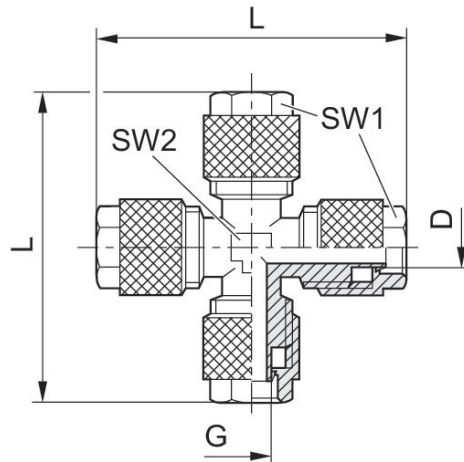

Part No.	Port D	Port G	L	SW 1	SW 2
1823391801	Ø 3	Ø 3	41.2	8	8
1823391802	Ø 4	Ø 4	40	10	8
1823391803	Ø 6	Ø 6	41	12	9
1823391804	Ø 8	Ø 8	44	14	11

Connection D = inside diameter of the tubing to be used