

# Filter, Series 652

## G652ABJK3JA000A

### General series information Series 652

- The AVENTICS Series 652 is an easy-to-install line of pneumatic filters, regulators and lubricators (FRLs) that offer the industry's highest flow rates and widest temperature ratings. Available in 1/4-inch, 3/8-inch, and 1/2-inch port sizes, these FRLs are ideal for automotive and tire, packaging, food and beverage, and process applications requiring highly reliable operation and robust, modern-looking equipment. Available with integrated redundant safe exhaust valve and IIoT enabled air flow sensor.



### Technical data

Industry	Industrial
Parts	Filter
Reservoir	Metal reservoir without window
Port	G 3/8
Filter porosity	25 µm
Nominal flow Qn	3390 l/min
Condensate drain	fully automatic, open without pressure
Working pressure min.	0 bar
Working pressure max	16 bar
Min. ambient temperature	-20 °C
Max. ambient temperature	50 °C
Medium	Compressed air Neutral gases

Medium temperature note	Extended temperature range min./max. (optional) -40 °C ... 80 °C
Certificates	ATEX optional
Weight	0.55 kg
Type	Can be assembled into blocks

## Material

Housing material	Aluminum
Seal material	Nitrile butadiene rubber
Material filter insert	Sintered polyethylene
Material condensate drain	Brass
Part No.	G652ABJK3JA000A

## Technical information

Max. achievable compressed air class acc. to ISO 8573-1:2010 5 : 8 : 4 (5 µm filter porosity) und 6 : 8 : 4 (25µm filter porosity)

Other filter porosities on request.

The pressure dew point must be at least 15 °C less than ambient and medium temperature and may not exceed 3 °C.

The oil content of compressed air must remain constant during the life cycle.

Use only the approved oils from AVENTICS. Further information can be found in the "Technical information" document (available in <https://www.emerson.com/en-us/support>).

## Dimensions

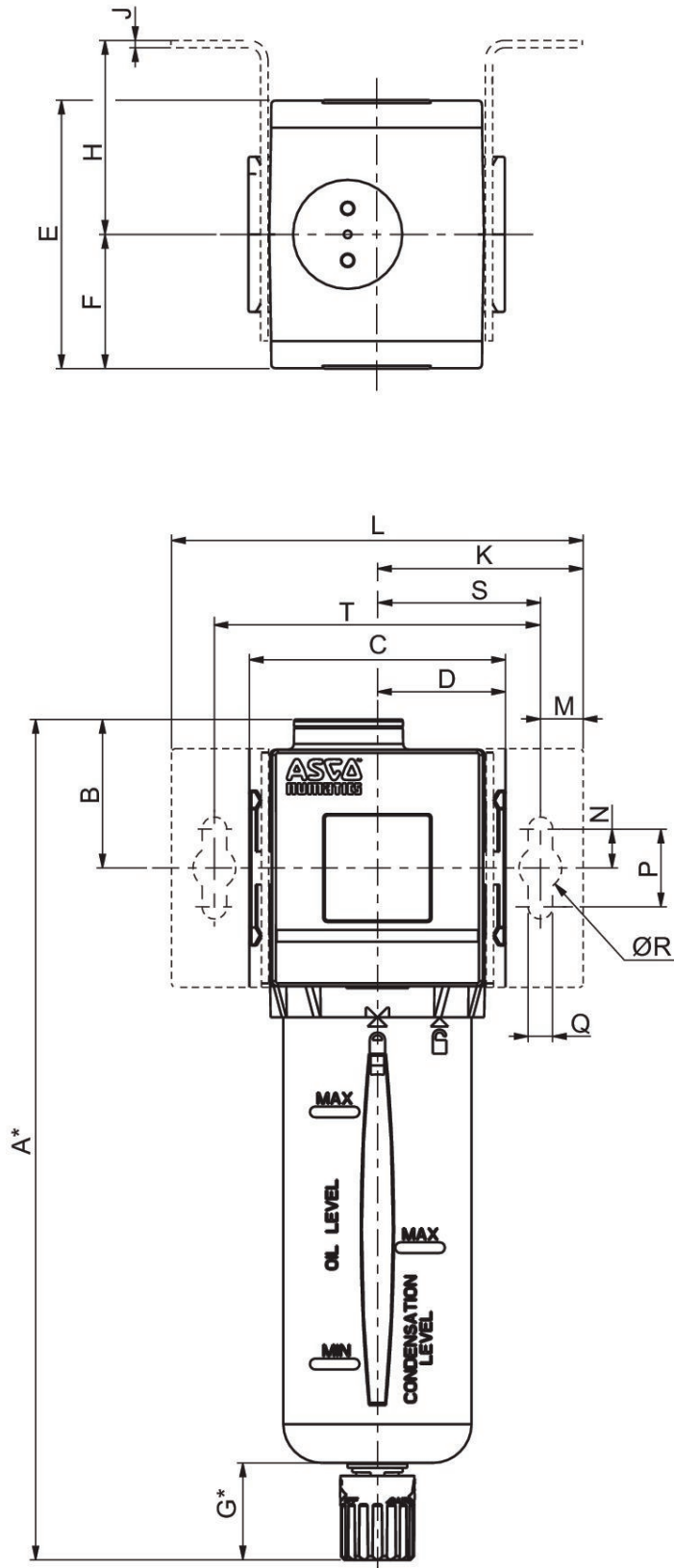

\*Variable dimension based on the type of drain specified, if an automatic drain is specified, add another [[5] mm] to the "G" dimension, which also adds 5 mm to the "A" dimension.

Series	652
A	217
B	38,3
C	66
D	33
E	69
F	34,5
G	25
H	50
J	1,9
K	53
L	106
M	11
N	10
P	20
Q	6,3
R	11
S	42
T	84

### Flow diagram G 1/2

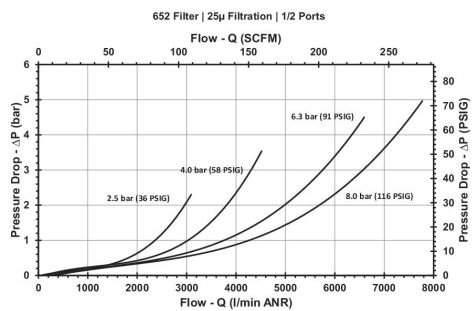

### Flow diagram G 3/8

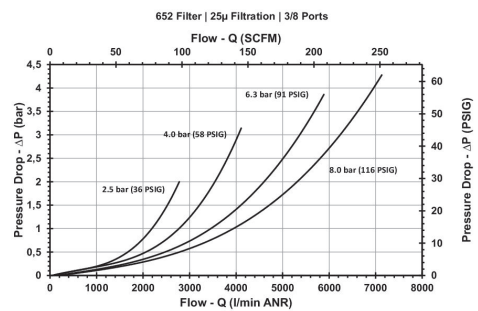

## Flow diagram G 1/4

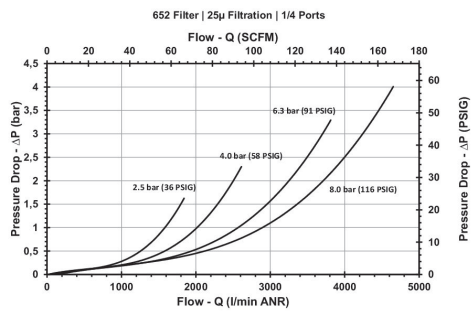

## Accessories overview

