

Series PG1 Pressure gauges

With the AVENTICS Series PG1 you can visualize and rely on a clear air pressure display for each of your pneumatic circuits. In addition to the parameters for controlling the air quality, supplying sufficient pressure is the basis for operating a reliable system within machine automation. Emerson offers mechanical pressure gauges that can be integrated into machines for diverse applications and air preparation systems. The specifications of the individual versions in the universal PG1 Series provide a selection of options, such as appearance, material, or the required type of mounting.



Technical data

Industry	Industrial
Pressure gauge version	Bourdon tube pressure gauge Back port
Standardization	EN 837-1
ATEX	Suitable for ATEX
Class	1,6
Compressed air connection	G 1/4
Nominal diameter	50 mm
Scale value	0.2
Min. range of application	0 bar
Max. range of application	4 bar
Min. display range	0 bar
Max. display range	6 bar
Min. working pressure	0 bar
Max. working pressure	6 bar
Min. ambient temperature	-40 °C
Max. ambient temperature	60 °C
Medium	Compressed air
Background color	Black
Main scale unit (outside)	bar

Pressure gauge, Series PG1-SNL

2024-05-22

1827231016

Main scale color (outside)	Green
Secondary scale unit (inside)	psi
Secondary scale color (inside)	White
Pointer color	White
Weight	0.09 kg

Material

Housing material	Acrylonitrile butadiene styrene
Material viewing window	Polystyrene
Material thread	Brass
	1827231016

Technical information

Order axial seal separately

Dimensions

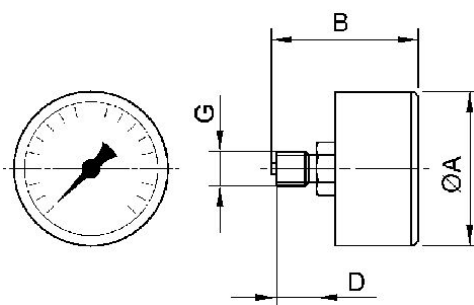

Dimensions in mm

Part No.	G	Nominal diameter	Ø A	B	D
1827231053	G 1/8	40 mm	39	44	10
1827231048	G 1/8	40 mm	39	44	10
1827231024	G 1/8	40 mm	39	44	10
1827231009	G 1/4	40 mm	39	44	10
1827231057	G 1/4	40 mm	41	41.5	10
1827231047	G 1/4	40 mm	41	41.5	10
1827231059	G 1/4	40 mm	41	41.5	10
1827231060	G 1/4	40 mm	41	41.5	10
1827231054	G 1/4	40 mm	49	47.5	13
1827231023	G 1/4	50 mm	49	47.5	13
1827231012	G 1/4	50 mm	49	47.5	13
1827231016	G 1/4	50 mm	49	47.5	13
1827231015	G 1/4	50 mm	49	47.5	13
1827231010	G 1/4	50 mm	49	47.5	13

Pressure gauge, Series PG1-SNL

2024-05-22

1827231016

Part No.	G	Nominal diameter	Ø A	B	D
1827231055	G 1/4	60 mm	63	48.3	13
1827231011	G 1/4	63 mm	63	48.3	13