

Series PG1 Pressure gauges

With the AVENTICS Series PG1 you can visualize and rely on a clear air pressure display for each of your pneumatic circuits. In addition to the parameters for controlling the air quality, supplying sufficient pressure is the basis for operating a reliable system within machine automation. Emerson offers mechanical pressure gauges that can be integrated into machines for diverse applications and air preparation systems. The specifications of the individual versions in the universal PG1 Series provide a selection of options, such as appearance, material, or the required type of mounting.



Technical data

Industry	Industrial
Pressure gauge version	Bourdon tube pressure gauge Back port with glycerin filling
Standardization	EN 837-1
Class	1,6
Compressed air connection	R 1/8
Nominal diameter	63 mm
Scale value	0.2
Min. range of application	0 bar
Max. range of application	4 bar
Min. display range	0 bar
Max. display range	6 bar
Min. working pressure	0 bar
Max. working pressure	6 bar
Min. ambient temperature	-25 °C
Max. ambient temperature	60 °C
Medium	Compressed air
Background color	White
Main scale unit (outside)	bar
Main scale color (outside)	Black
Secondary scale unit (inside)	psi
Secondary scale color (inside)	Black
Pointer color	Black
Weight	0.26 kg

Material

Housing material	Stainless Steel
Material viewing window	Polystyrene

Pressure gauge, Series PG1-GLY

2024-05-22

R412010127

Material thread

Brass

R412010127

Technical information

Order axial seal separately

Dimensions in mm

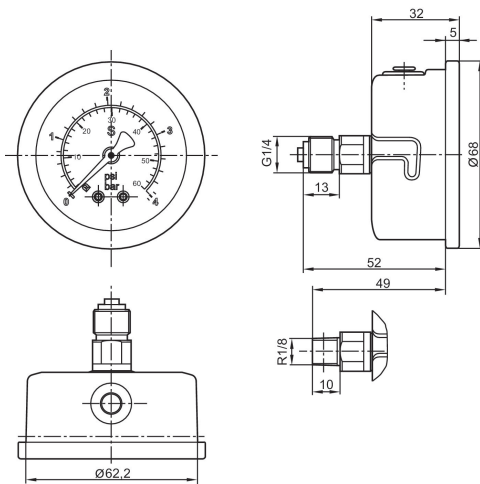

Order retainer ring 3530132602 for control panel installation separately.