

Profile cylinder ISO 15552, Series PRA - inch

R480176232

AVENTICS
Series
PRA Profile
cylinders
(ISO 15552)

AVENTICS Series PRA Profile cylinders (ISO 15552)

The AVENTICS Series PRA (ISO 15552) cylinders have a compact design profile with integrated sensor slots. The Series PRA (ISO 15552) cylinders can be used for all industries. This includes general automation technology, machine and systems construction, as well as specific industry applications.



Technical data

Industry	Industrial
Piston Ø	32 mm
Stroke	304.8 mm
Ports	1/8 NPT
Functional principle	Double-acting
Cushioning	Pneumatic adjustable cushioning
Magnetic piston	Piston with magnet
Environmental requirements	Industry standard ATEX optional
Piston rod thread - type	External thread
Piston rod thread	7/16-20 UNF
Piston rod	single
Scraper	Standard Industry Scraper
Pressure for determining piston forces	6,3 bar
Retracting piston force	435 N
Extracting piston force	505 N
Min. ambient temperature	-20 °C
Max. ambient temperature	80 °C
Min. working pressure	2 bar
Max. working pressure	10 bar

Profile cylinder ISO 15552, Series PRA - inch

R480176232

AVENTICS
Series
PRA Profile
cylinders
(ISO 15552)

2024-04-12

Cushioning length	16.5 mm
Cushioning energy	4.8 J
Weight 0 mm stroke	0.5 kg
Weight +10 mm stroke	0.022 kg
Stroke max.	1600 mm
Medium	Compressed air
Min. medium temperature	-20 °C
Max. medium temperature	80 °C
Max. particle size	50 µm
Min. oil content of compressed air	0 mg/m ³
Max. oil content of compressed air	5 mg/m ³

Material

Piston rod	Stainless Steel
Scraper material	Polyurethane
Seal material	Polyurethane
Material, front cover	Die-cast aluminum
Cylinder tube	Aluminum
End cover	Die-cast aluminum
Nut for piston rod	Steel, chrome-plated
Part No.	R480176232

Technical information

The pressure dew point must be at least 15 °C less than ambient and medium temperature and may not exceed 3 °C.

The oil content of compressed air must remain constant during the life cycle.

Use only the approved oils from AVENTICS. Further information can be found in the "Technical information" document (available in <https://www.emerson.com/en-us/support>).

Profile cylinder ISO 1552, Series PRA - inch

R480176232

AVENTICS
Series
PRA Profile
cylinders
(ISO 1552)

Dimensions

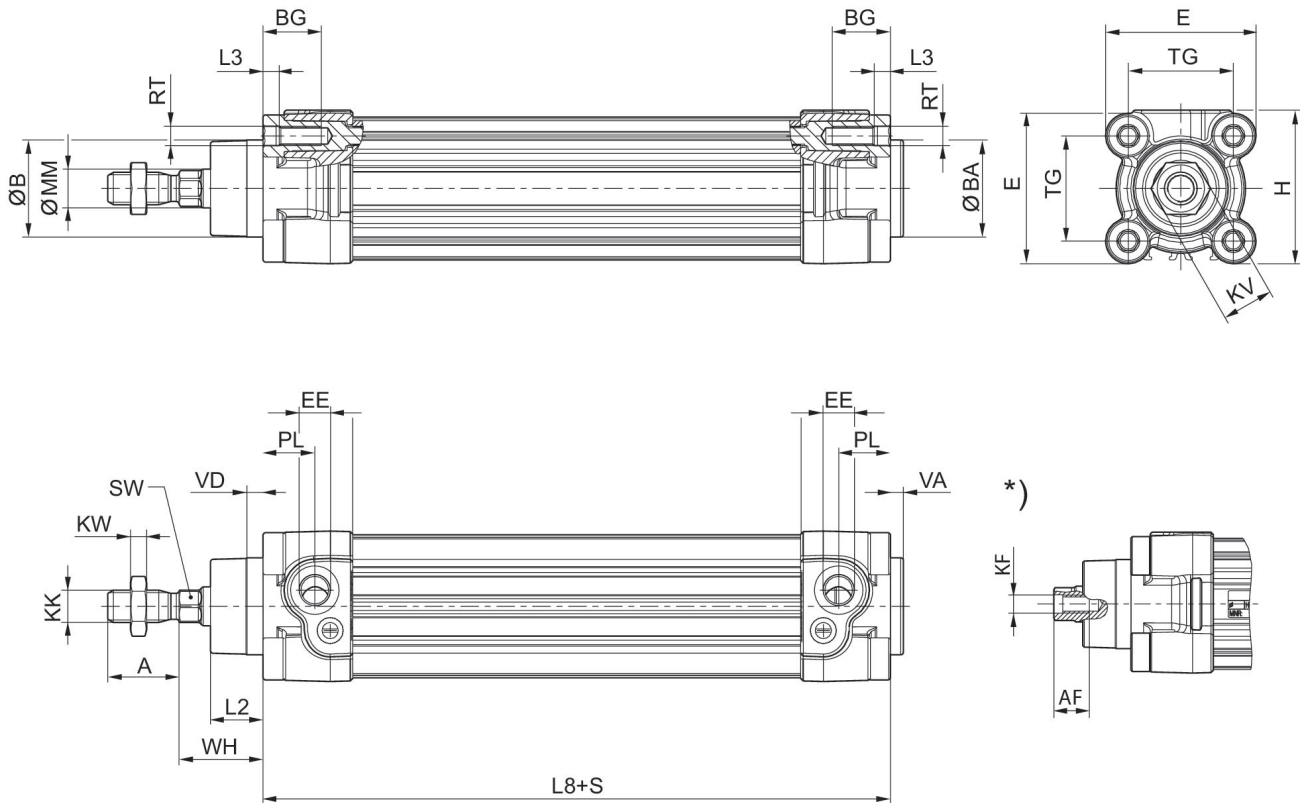

S = stroke
* Internal thread

Piston Ø	A -2	ØB d11	ØBA d11	BG min.	E	EE inch	EE	H	KK inch
32	22	30	30	16	46.5	1/8 NPT	G 1/8	47.5	7/16 - 20 UNF
40	24	35	35	16	53	1/4 NPT	G 1/4	53	1/2 - 20 UNF
50	32	40	40	16	65	1/4 NPT	G 1/4	65	3/4 - 16 UNF
63	32	45	45	16	75	3/8 NPT	G 3/8	75	3/4 - 16 UNF
80	40	45	45	17	95	3/8 NPT	G 3/8	95	3/4 - 16 UNF
100	40	55	55	17	115	1/2 NPT	G 1/2	115	3/4 - 16 UNF
125	54	60	60	20	140	1/2 NPT	G 1/2	140	1 - 14 UNF

Piston Ø	KK	KV	KW	ØMM f8	PL	L2	L3 ±0,5	L8	RT
32	M10x1,25	16	5	12	16	16.25	4.5	94±0,4	M6
40	M12x1,25	18	6	16	20	18.25	4.5	105±0,7	M6
50	M16x1,5	24	8	20	19	25	4.5	106±0,7	M8
63	M16x1,5	24	8	20	24	25	4.5	121±0,8	M8
80	M20x1,5	30	10	25	23.5	33	0	128±0,8	M10
100	M20x1,5	30	10	25	25	36	0	138±1	M10
125	M27x2	41	13.5	32	33	45	0	160±1	M12

Profile cylinder ISO 15552, Series PRA - inch

R480176232

AVENTICS
Series
PRA Profile
cylinders
(ISO 15552)

2024-04-12

Piston Ø	SW	TG	VA -1	VD	WH
32	10	32,5±0,5	4	5	26±1,4
40	13	38±0,5	4	5	30±1,4
50	17	46,5±0,6	4	5	37±1,4
63	17	56,5±0,7	4	5	37±1,8
80	22	72±0,7	4	5	46±1,8
100	22	89±0,7	4	5	51±1,8
125	27	110±1,1	6	7	65±2,2

Cushioning diagram

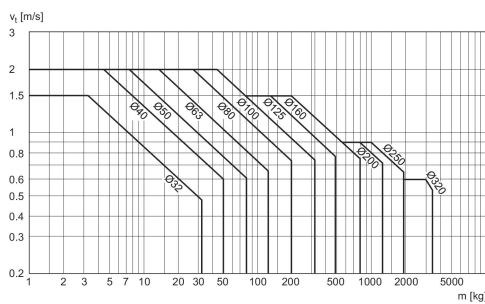

v_t = Piston velocity [m/s] m = Cushionable mass [kg]

Profile cylinder ISO 1552, Series PRA - inch

R480176232

AVENTICS
Series
PRA Profile
cylinders
(ISO 1552)

I-12

Overview drawing

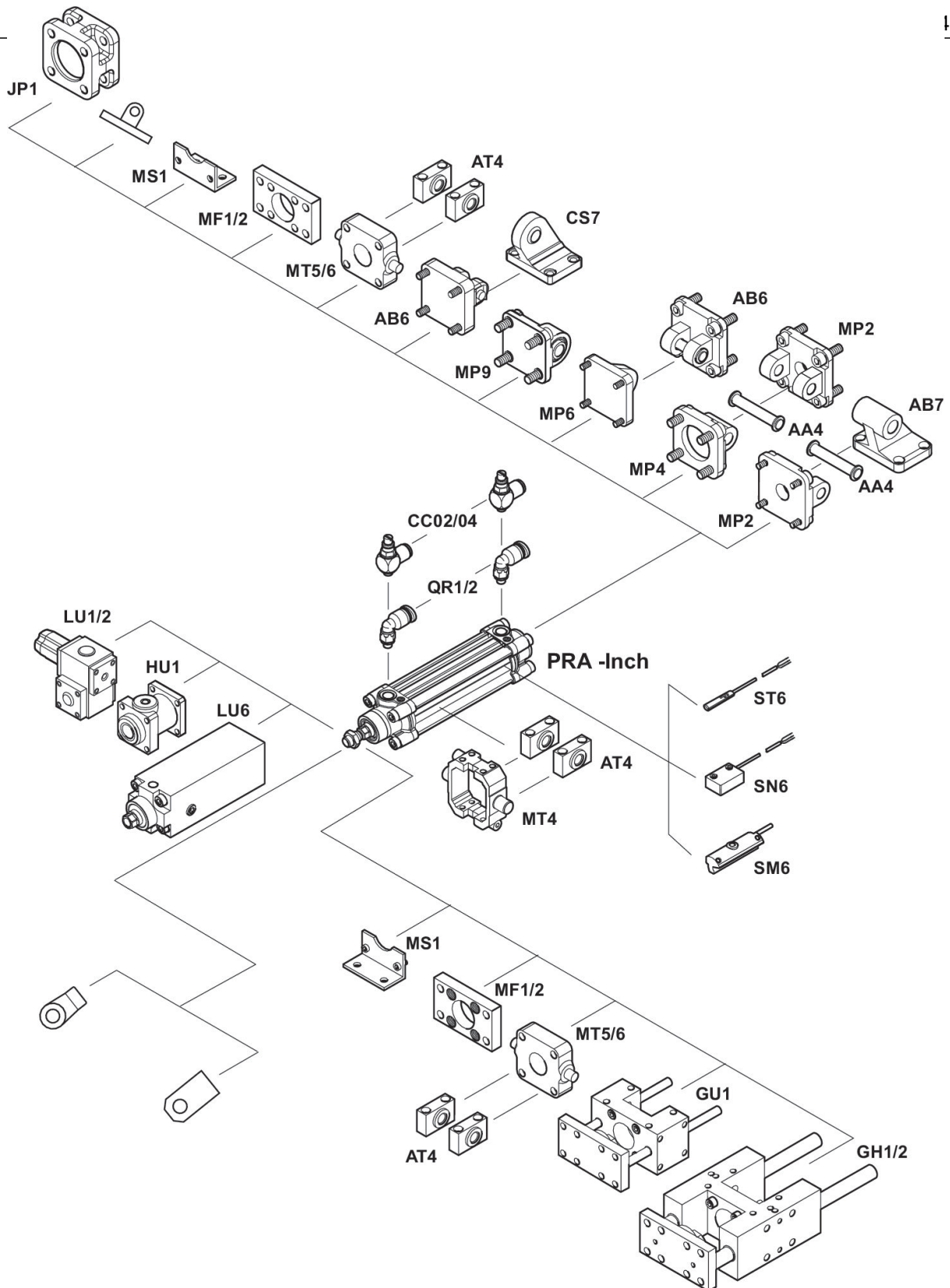

NOTE: This overview drawing is only for orientation to indicate where the various accessory parts can be fastened to the cylinder. The illustration has been simplified for this purpose. It is thus not possible to derive the dimensions from this overview.