

AVENTICS Series PRA Profile cylinders (ISO 15552)

The AVENTICS Series PRA (ISO 15552) cylinders have a compact design profile with integrated sensor slots. The Series PRA (ISO 15552) cylinders can be used for all industries. This includes general automation technology, machine and systems construction, as well as specific industry applications.



Technical data

| | |
|--|------------------------------------|
| Industry | Industrial |
| Standards | ISO 15552 |
| Piston Ø | 32 mm |
| Stroke | 250 mm |
| Ports | G 1/8 |
| Functional principle | Double-acting |
| Cushioning | Pneumatic adjustable cushioning |
| Magnetic piston | Piston with magnet |
| Environmental requirements | Industry standard ATEX optional |
| Piston rod thread - type | External thread |
| Piston rod thread | M10x1,25 |
| Piston rod | through |
| Scraper | Standard Industry Scraper |
| Pressure for determining piston forces | 6,3 bar |
| Retracting piston force | 435 N |
| Extracting piston force | 435 N |
| Min. ambient temperature | -20 °C |
| Max. ambient temperature | 80 °C |
| Min. working pressure | 1.5 bar |

Profile cylinder ISO 15552, PRA series

series PRA

R480041426

2024-04-12

| | |
|------------------------------------|---------------------|
| Max. working pressure | 10 bar |
| Cushioning length | 16.5 mm |
| Cushioning energy | 4.8 J |
| Weight 0 mm stroke | 0.58 kg |
| Weight +10 mm stroke | 0.031 kg |
| Stroke max. | 1500 mm |
| Medium | Compressed air |
| Min. medium temperature | -20 °C |
| Max. medium temperature | 80 °C |
| Max. particle size | 50 µm |
| Min. oil content of compressed air | 0 mg/m ³ |
| Max. oil content of compressed air | 5 mg/m ³ |

Material

| | |
|-----------------------|----------------------|
| Piston rod | Stainless Steel |
| Scraper material | Polyurethane |
| Seal material | Polyurethane |
| Material, front cover | Die-cast aluminum |
| Cylinder tube | Aluminum |
| End cover | Die-cast aluminum |
| Nut for piston rod | Steel, chrome-plated |
| Part No. | R480041426 |

Technical information

The pressure dew point must be at least 15 °C less than ambient and medium temperature and may not exceed 3 °C.

The oil content of compressed air must remain constant during the life cycle.

Use only the approved oils from AVENTICS. Further information can be found in the “Technical information” document (available in <https://www.emerson.com/en-us/support>).

Profile cylinder ISO 1552, PRA series

R480041426

series PRA

2024-04-12

Dimensions

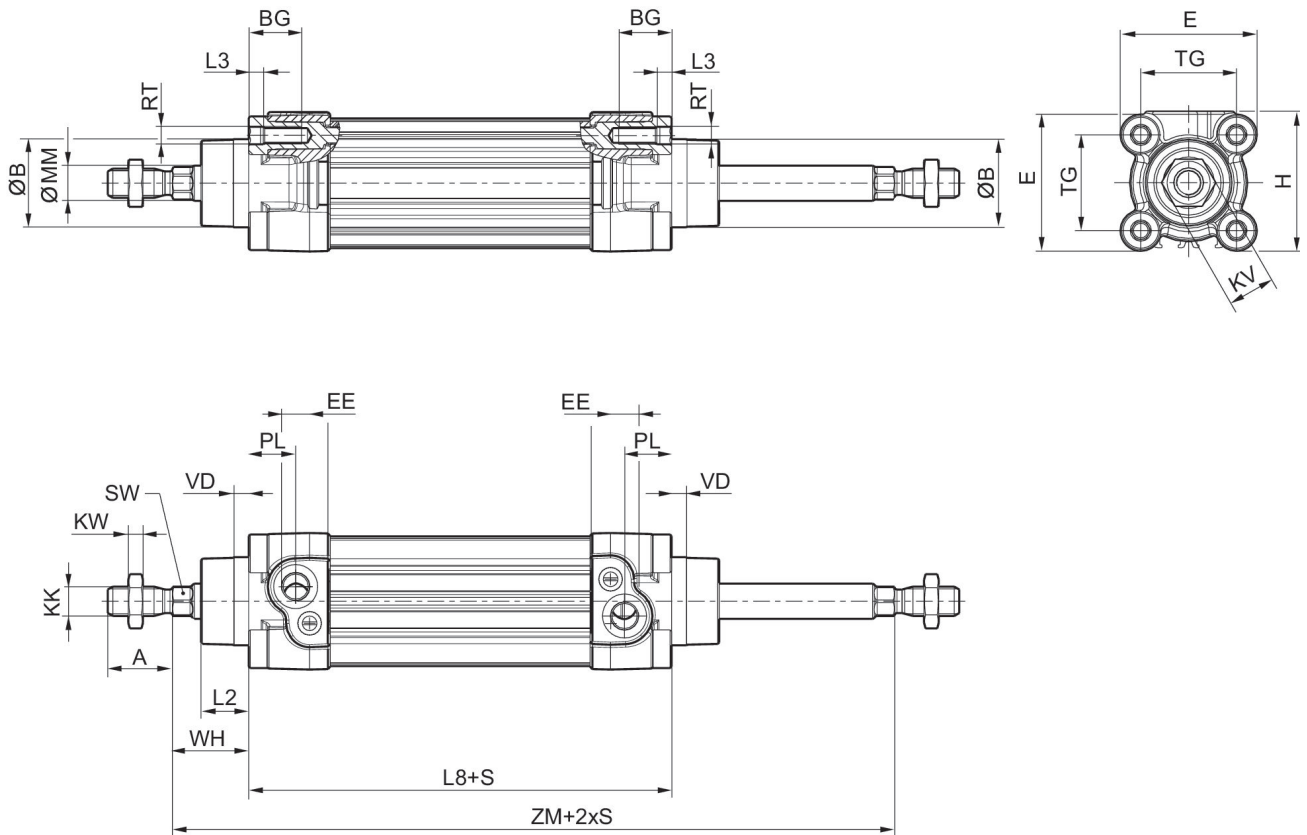

S = stroke

| Piston Ø | A -2 | ØB d11 | BG min. | E | EE | G | H | KK | KV |
|----------|------|--------|---------|------|-------|-------|------|----------|----|
| 32 | 22 | 30 | 16 | 46.5 | G 1/8 | 27.75 | 47.5 | M10x1,25 | 16 |
| 40 | 24 | 35 | 16 | 53 | G 1/4 | 33.25 | 53 | M12x1,25 | 18 |
| 50 | 32 | 40 | 16 | 65 | G 1/4 | 31 | 65 | M16x1,5 | 24 |
| 63 | 32 | 45 | 16 | 75 | G 3/8 | 38.25 | 75 | M16x1,5 | 24 |
| 80 | 40 | 45 | 17 | 95 | G 3/8 | 38.25 | 95 | M20x1,5 | 30 |
| 100 | 40 | 55 | 17 | 115 | G 1/2 | 42.25 | 115 | M20x1,5 | 30 |
| 125 | 54 | 60 | 20 | 140 | G 1/2 | 53.85 | 140 | M27x2 | 41 |

| Piston Ø | KW | ØMM f8 | PL | L2 | L3 ±0,5 | L8 | RT | SW | TG |
|----------|------|--------|------|-------|---------|---------|-----|----|----------|
| 32 | 5 | 12 | 16 | 16.25 | 4.5 | 94±0,4 | M6 | 10 | 32,5±0,5 |
| 40 | 6 | 16 | 20 | 18.25 | 4.5 | 105±0,7 | M6 | 13 | 38±0,5 |
| 50 | 8 | 20 | 19 | 25 | 4.5 | 106±0,7 | M8 | 17 | 46,5±0,6 |
| 63 | 8 | 20 | 24 | 25 | 4.5 | 121±0,8 | M8 | 17 | 56,5±0,7 |
| 80 | 10 | 25 | 23.5 | 33 | 0 | 128±0,8 | M10 | 22 | 72±0,7 |
| 100 | 10 | 25 | 25 | 36 | 0 | 138±1 | M10 | 22 | 89±0,7 |
| 125 | 13.5 | 32 | 33 | 45 | 0 | 160±1 | M12 | 27 | 110±1,1 |

Profile cylinder ISO 15552, PRA series

R480041426

series PRA

2024-04-12

| Piston Ø | VD | WH | ZM |
|----------|----|--------|------------|
| 32 | 5 | 26±1,4 | 146+3/-1,5 |
| 40 | 5 | 30±1,4 | 165+3/-1,5 |
| 50 | 5 | 37±1,4 | 180+3/-1,5 |
| 63 | 5 | 37±1,8 | 195+3/-1,5 |
| 80 | 5 | 46±1,8 | 220+3/-1,5 |
| 100 | 5 | 51±1,8 | 240+3,5/-2 |
| 125 | 7 | 65±2,2 | 290+3,5/-2 |

Cushioning diagram



v_t = Piston velocity [m/s] m = Cushionable mass [kg]

Profile cylinder ISO 1552, PRA series

R480041426

series PRA

2024-04-12

