

AVENTICS Series PRA Profile cylinders (ISO 15552)

The AVENTICS Series PRA (ISO 15552) cylinders have a compact design profile with integrated sensor slots. The Series PRA (ISO 15552) cylinders can be used for all industries. This includes general automation technology, machine and systems construction, as well as specific industry applications.



Technical data

Industry	Industrial
Standards	ISO 15552
Piston Ø	50 mm
Stroke	320 mm
Ports	G 1/4
Functional principle	Double-acting
Cushioning	Pneumatic adjustable cushioning
Magnetic piston	Piston with magnet
Environmental requirements	Industry standard Heat resistant
Piston rod thread - type	External thread
Piston rod thread	M16x1,5
Piston rod	single
Scraper	Heat-Resistant Scraper
Pressure for determining piston forces	6,3 bar
Retracting piston force	1035 N
Extracting piston force	1235 N
Min. ambient temperature	-10 °C
Max. ambient temperature	120 °C
Min. working pressure	2 bar

Profile cylinder ISO 15552, PRA series

series PRA

R412014183

2024-04-12

Max. working pressure	10 bar
Cushioning length	17 mm
Cushioning energy	15 J
Weight 0 mm stroke	1.06 kg
Weight +10 mm stroke	0.047 kg
Stroke max.	2100 mm
Medium	Compressed air
Min. medium temperature	-10 °C
Max. medium temperature	120 °C
Max. particle size	50 µm
Min. oil content of compressed air	0 mg/m ³
Max. oil content of compressed air	5 mg/m ³

Material

Piston rod	Stainless Steel
Scraper material	Fluorocautchouc
Seal material	Fluorocautchouc
Material, front cover	Die-cast aluminum
Cylinder tube	Aluminum
End cover	Die-cast aluminum
Nut for piston rod	Steel, chrome-plated
Part No.	R412014183

Technical information

The pressure dew point must be at least 15 °C less than ambient and medium temperature and may not exceed 3 °C.

The oil content of compressed air must remain constant during the life cycle.

Use only the approved oils from AVENTICS. Further information can be found in the “Technical information” document (available in <https://www.emerson.com/en-us/support>).

Profile cylinder ISO 1552, PRA series

R412014183

series PRA

2024-04-12

Dimensions

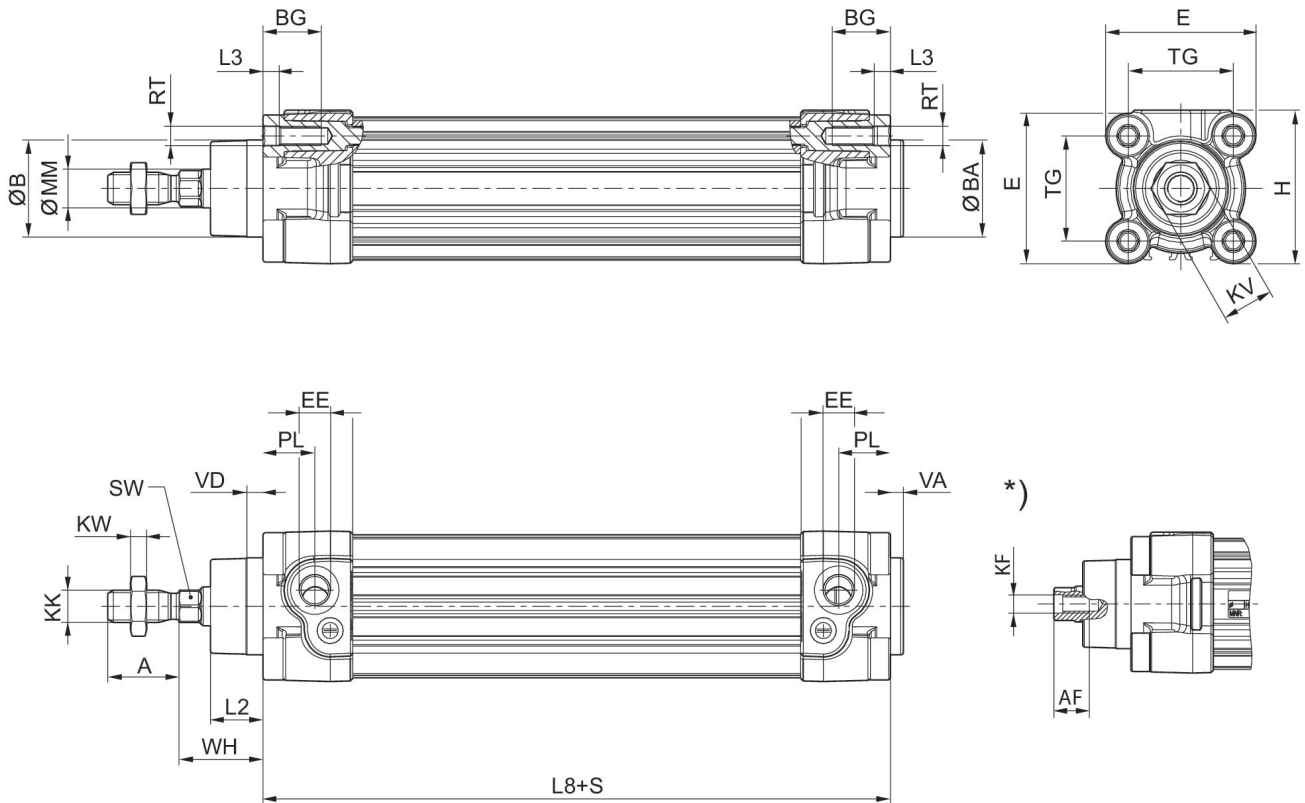

S = stroke
* Internal thread

Piston \varnothing	A -2	AF+1	$\varnothing B$ d11	$\varnothing BA$ d11	BG min.	E	EE	G	H
32	22	12	30	30	16	46.5	G 1/8	27.75	47.5
40	24	13.5	35	35	16	53	G 1/4	33.25	53
50	32	17	40	40	16	65	G 1/4	31	65
63	32	17	45	45	16	75	G 3/8	38.25	75
80	40	21	45	45	17	95	G 3/8	38.25	95
100	40	21	55	55	17	115	G 1/2	42.25	115
125	54	28	60	60	20	140	G 1/2	53.85	140

Piston \varnothing	KF	KK	KV	KW	$\varnothing MM$ f8	PL	L2	L3 $\pm 0,5$	L8
32	M6	M10x1,25	16	5	12	16	16.25	4.5	94 $\pm 0,4$
40	M8	M12x1,25	18	6	16	20	18.25	4.5	105 $\pm 0,7$
50	M10	M16x1,5	24	8	20	19	25	4.5	106 $\pm 0,7$
63	M10	M16x1,5	24	8	20	24	25	4.5	121 $\pm 0,8$
80	M12	M20x1,5	30	10	25	23.5	33	0	128 $\pm 0,8$
100	M12	M20x1,5	30	10	25	25	36	0	138 ± 1
125	M16	M27x2	41	13.5	32	33	45	0	160 ± 1

Piston \varnothing	RT	SW	TG	VA -1	VD	WH
32	M6	10	32,5 $\pm 0,5$	4	5	26 $\pm 1,4$

Profile cylinder ISO 15552, PRA series

R412014183

series PRA

2024-04-12

Piston Ø	RT	SW	TG	VA -1	VD	WH
40	M6	13	38±0,5	4	5	30±1,4
50	M8	17	46,5±0,6	4	5	37±1,4
63	M8	17	56,5±0,7	4	5	37±1,8
80	M10	22	72±0,7	4	5	46±1,8
100	M10	22	89±0,7	4	5	51±1,8
125	M12	27	110±1,1	6	7	65±2,2

Cushioning diagram



v_i = Piston velocity [m/s] m = Cushionable mass [kg]

Profile cylinder ISO 1552, PRA series

R412014183

series PRA

2024-04-12

