

AVENTICS Series PRA Profile cylinders (ISO 15552)

The AVENTICS Series PRA (ISO 15552) cylinders have a compact design profile with integrated sensor slots. The Series PRA (ISO 15552) cylinders can be used for all industries. This includes general automation technology, machine and systems construction, as well as specific industry applications.

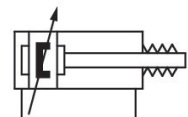

Technical data

Industry	Industrial
Standards	ISO 15552
Piston Ø	80 mm
Stroke	100 mm
Ports	G 3/8
Functional principle	Double-acting
Cushioning	Pneumatic adjustable cushioning
Magnetic piston	Piston with magnet
Environmental requirements	Industry standard
Piston rod thread - type	External thread
Piston rod thread	M20x1,5
Piston rod	single
Cylinder special features	Bellows
Scraper	Standard Industry Scraper
Pressure for determining piston forces	6,3 bar
Retracting piston force	2855 N
Extracting piston force	3165 N
Min. ambient temperature	-20 °C
Max. ambient temperature	80 °C

Profile cylinder ISO 15552, PRA series

R481602101

series PRA

2024-04-12

Min. working pressure	1.5 bar
Max. working pressure	10 bar
Max. speed	0.7 m/s
Cushioning length	19.5 mm
Cushioning energy	54 J
Stroke max.	1000 mm
Medium	Compressed air
Min. medium temperature	-20 °C
Max. medium temperature	80 °C
Max. particle size	50 µm
Min. oil content of compressed air	0 mg/m ³
Max. oil content of compressed air	5 mg/m ³

Material

Piston rod	Stainless Steel
Scraper material	Polyurethane
Seal material	Polyurethane
Material, front cover	Die-cast aluminum
Cylinder tube	Aluminum
End cover	Die-cast aluminum
Nut for piston rod	Steel, chrome-plated
Bellow	Carboxylated nitrile rubber
Part No.	R481602101

Technical information

The pressure dew point must be at least 15 °C less than ambient and medium temperature and may not exceed 3 °C.

The oil content of compressed air must remain constant during the life cycle.

Use only the approved oils from AVENTICS. Further information can be found in the “Technical information” document (available in <https://www.emerson.com/en-us/support>).

Profile cylinder ISO 1552, PRA series

R481602101

series PRA

2024-04-12

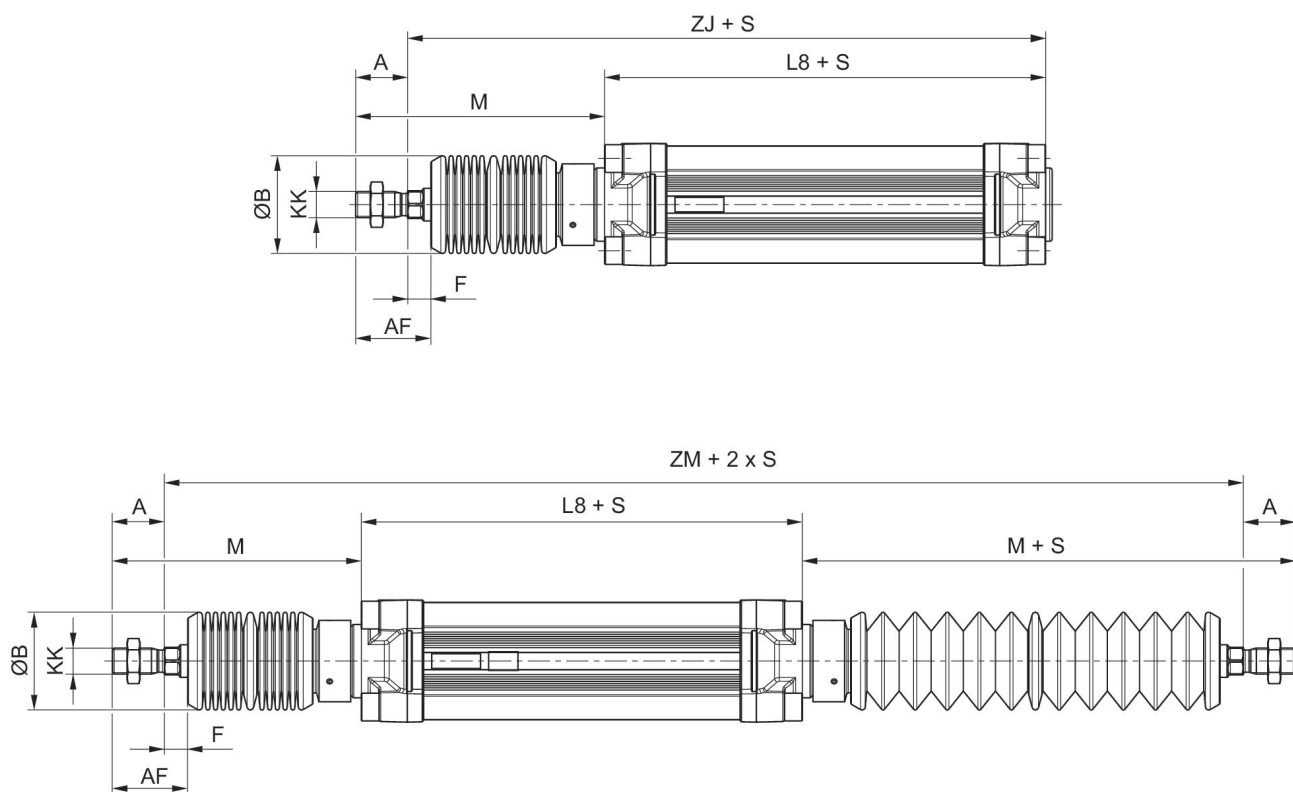

S = stroke

Stroke-dependent dimensions

Piston Ø	S=0-75 M	S=0-75 ZJ	S=0-75 ZM	S=76-150 M	S=76-150 ZJ	S=76-150 ZM	S=151-250 M	S=151-250 ZJ	S=151-250 ZM
32	81	153	212	107	179	264	127	199	304
40	138	219	333	138	219	333	138	219	333
50	153	227	348	153	227	348	153	227	348
63	153	242	363	153	242	363	153	242	363
80	170	258	388	170	258	388	170	258	388
100	160	258	378	160	258	378	160	258	378
125	188	294	418	188	294	428	188	294	428

Piston Ø	S=251-5000 M	S=251-500 ZJ	S=251-500 ZM	S=501-750 M	S=501-750 ZJ	S=501-750 ZM	S=751-1000 M	S=751-1000 ZJ	S=751-1000 ZM
32	-	-	-	-	-	-	-	-	-
40	218	299	493	-	-	-	-	-	-
50	233	307	508	313	387	668	-	-	-
63	233	322	523	313	402	683	394	483	845
80	250	338	548	330	418	708	411	499	870
100	220	318	498	280	378	618	340	438	738
125	248	354	548	308	414	668	368	474	788

S = stroke

Profile cylinder ISO 15552, PRA series

R481602101

series PRA

2024-04-12

	A	Ø B	KK	L8	AF	F
R481602057	22	42	M10x1.25	94	34	12
R481602065	24	42	M12x1.25	105	39	15
R481602076	32	64	M16x1,5	106	47	15
R481602087	32	64	M16x1,5	121	47	15
R481602098	40	64	M20x1,5	128	57	17
R481602109	40	64	M20x1,5	138	57	17
R481602120	54	94	M27x2	160	71	17

Cushioning diagram



v_1 = Piston velocity [m/s] m = Cushionable mass [kg]

Profile cylinder ISO 1552, PRA series

R481602101

series PRA

2024-04-12

