

# Blocking valve, Series QR1-AVT

R432000450

Series QR1

- $Q_n = 280 \dots 2000 \text{ l/min}$

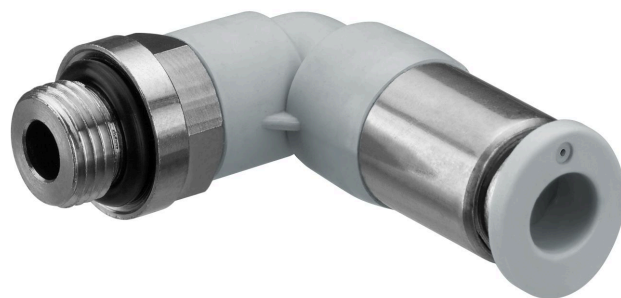

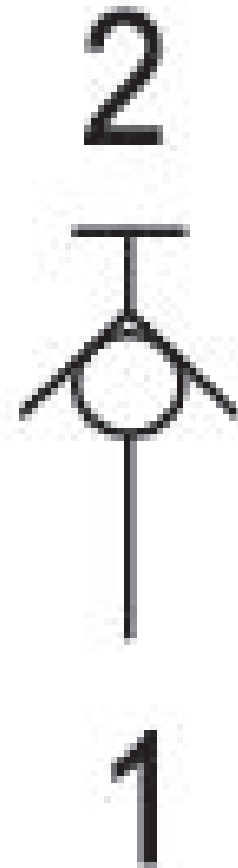

## Technical data

Industry	Industrial
Compressed air connection 1	3/8 NPT
Compressed air connection type 1	External thread
Compressed air connection type 2	push-in fitting
Type	Poppet valve
Compressed air connection 2	Ø 3/8
Nominal flow Qn 1 to 2	300 l/min
Working pressure min.	0 bar
Working pressure max	10 bar
Min. ambient temperature	0 °C
Max. ambient temperature	60 °C
Min. medium temperature	0 °C
Max. medium temperature	60 °C
Medium	Compressed air
Delivery unit	5 piece
Weight	0.068 kg

## Material

Housing material	Brass
Surface housing	nickel-plated
Seal material	Acrylonitrile butadiene rubber
Part No.	R432000450

## Technical information

When connecting/disconnecting the compressed air tubing and shut-off valve, the flow is released/ blocked.

## Dimensions in inches

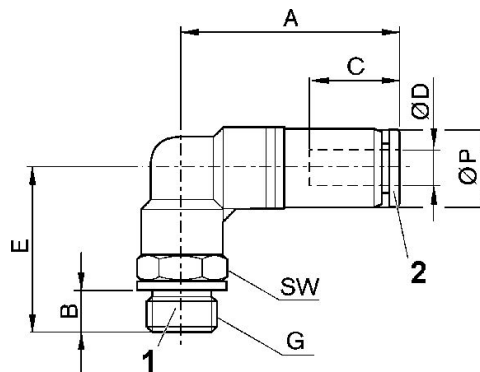

Part No.	G	Ø D	A	B	C	E	SW	Ø P
R432000456	3/8 NPT	Ø 3/8	1.21	0.217	0.63	0.871	7/16	0.411
R432000448	3/8 NPT	Ø 3/8	1.257	0.217	0.67	0.89	1/2	0.489
R432000455	3/8 NPT	Ø 3/8	1.21	0.315	0.63	0.969	7/16	0.411
R432000446	3/8 NPT	Ø 3/8	1.257	0.315	0.67	0.945	1/2	0.489
R432000452	3/8 NPT	Ø 3/8	1.608	0.315	0.729	1.064	9/16	0.567
R432000447	3/8 NPT	Ø 3/8	1.257	0.433	0.67	1.103	9/16	0.489
R432000453	3/8 NPT	Ø 3/8	1.608	0.433	0.729	1.221	9/16	0.567
R432000449	3/8 NPT	Ø 3/8	1.875	0.433	0.827	1.379	11/16	0.693
R432000454	3/8 NPT	Ø 3/8	1.608	0.473	0.729	1.261	11/16	0.567
R432000450	3/8 NPT	Ø 3/8	1.875	0.473	0.827	1.418	11/16	0.693
R432000444	3/8 NPT	Ø 3/8	2.187	0.473	0.887	1.497	7/8	0.835
R432000451	3/8 NPT	Ø 3/8	1.875	0.591	0.827	1.537	7/8	0.693