

# Bulkhead ball valve, Series QR1-BSS

R432000401

General series information  
AVENTICS Series QR1 Shut-off valves

- AVENTICS Series QR1 Shut-off valve are designed for safety-relevant processes, the valves enable manual blocking of the air supply to immediately stop the working stroke.

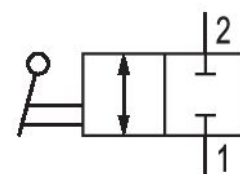
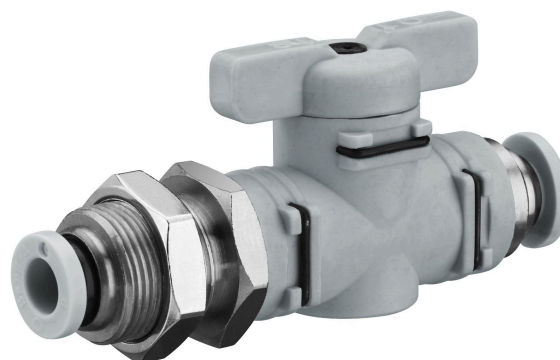

## Technical data

Industry	Industrial
Type	Ball Valve
Medium	Compressed air
Compressed air connection 1	Ø1/4
Compressed air connection type 1	push-in fitting
Compressed air connection 2	Ø1/4
Compressed air connection type 2	push-in fitting
Min. ambient temperature	0 °C
Max. ambient temperature	60 °C
Min. medium temperature	0 °C
Max. medium temperature	60 °C
Working pressure min.	-0.95 bar
Working pressure max	10 bar
Flow Qn	1000 l/min
Delivery unit	5 piece

Weight 0.0453 kg

### Material

Housing material Polybutyleneterephthalate  
Material hand lever Polybutyleneterephthalate  
Part No. R432000401

### Dimensions in inches

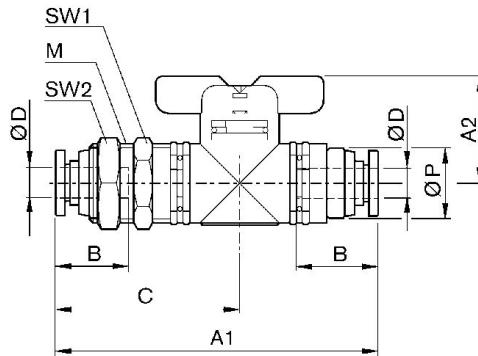

### Dimensions in inches

Part No.	Ø D1	Ø D2	M	A1	A2	B	C	SW1	SW2
R432000401	Ø1/4	Ø1/4	UNF 5/8	2.9	0.906	0.67	1.73	3/4	3/4
R432000403	Ø5/16	Ø1/4	UNF 5/8	2.92	0.906	0.729	1.749	3/4	3/4
R432000404	Ø5/16	Ø5/16	UNF 5/8	2.92	0.906	0.729	1.749	3/4	3/4
R432000402	Ø 3/8	Ø1/4	UNF 7/8	3.7	1.103	0.827	2.191	1	1
R432000400	Ø1/2	Ø1/4	UNF 7/8	3.684	1.103	0.827	2.191	1	1

Part No.	Ø P
R432000401	0.67
R432000403	0.67
R432000404	0.67
R432000402	0.945
R432000400	0.945