

Check-choke valve, Series QR1-DWA

R432002375

General series information
QR1-DWA

- AVENTICS Series QR1 Check-choke-valve are designed for nominal flows from 60 l/min .. 875 l/min.

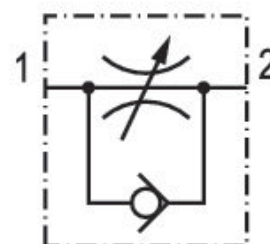

Technical data

Industry	Industrial
Port 1	3/8 NPT
Port 2	Ø5/16
direction of throttle	1 > 2
Nominal flow Q _n 1 to 2	33003.36 l/min
Compressed air connection type 1	push-in fitting
Compressed air connection type 2	External thread
Throttle	Exhaust Air Throttling
Medium	Compressed air
Working pressure min.	0.4827 bar
Working pressure max	10 bar
Min. ambient temperature	0 °C
Max. ambient temperature	60 °C

Min. medium temperature	0 °C
Max. medium temperature	60 °C
Delivery unit	1 piece
Weight	0.0635 kg

Material

Housing material	Polybutyleneterephthalate
Seal material	Acrylonitrile butadiene rubber
Material flow control screw	Brass
Surface flow control screw	nickel-plated
Material compressed air connection	Brass
Part No.	R432002375

Technical information

The min. control pressure must be adhered to, since otherwise faulty switching and valve failure may result!

The pressure dew point must be at least 15 °C less than ambient and medium temperature and may not exceed 3 °C.

The oil content of compressed air must remain constant during the life cycle.

Use only the approved oils from AVENTICS. Further information can be found in the "Technical information" document (available in <https://www.emerson.com/en-us/support>).

Dimensions in inches

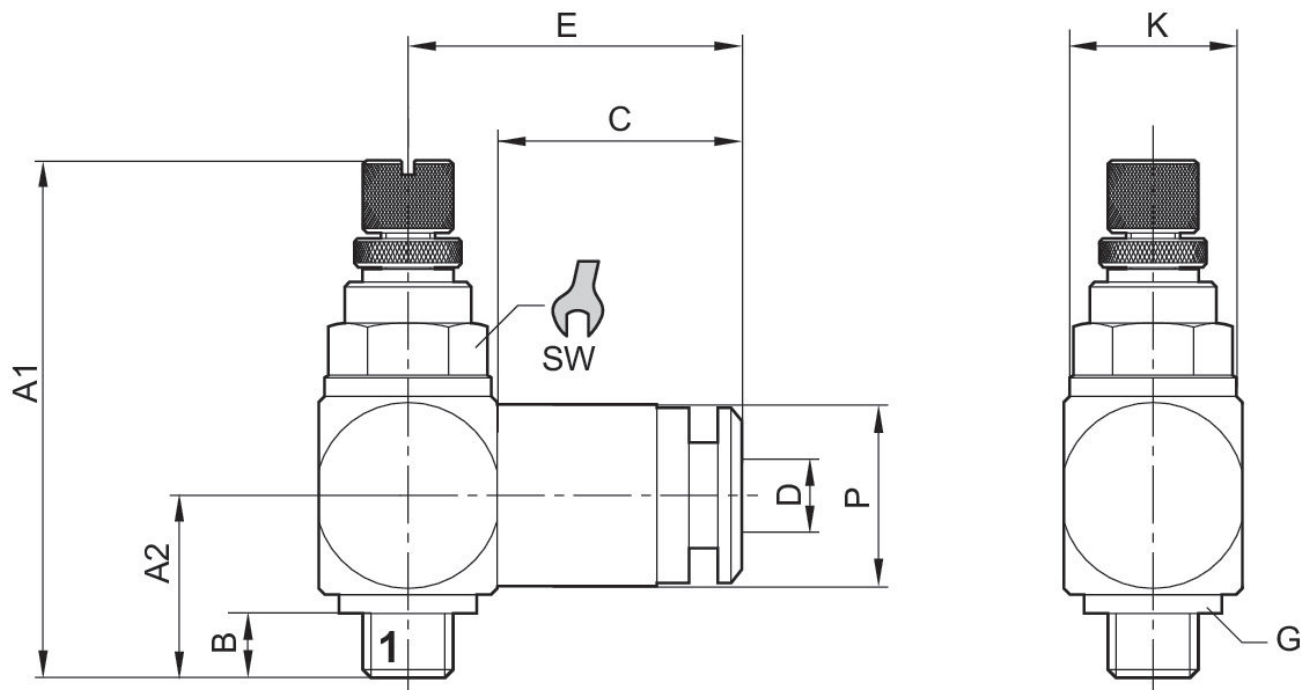

Throttle setting via knurled bolt

Dimensions in inches

Part No.	Ø D	A1 (max)	A2	B	C	E	Ø K	SW	Ø P
R432002367	5/32	1,044	0,256	0,138	0,63	0,725	0,394	5/16	0,411
R432002369	1/4	1,852	0,591	0,493	0,67	0,839	0,394	5/16	0,489
R432002368	5/32	1,044	0,256	0,138	0,63	0,725	0,394	7/16	0,411
R432002370	1/4	1,418	0,473	0,276	0,67	0,855	0,567	7/16	0,489
R432002373	5/16	2,049	0,619	0,611	0,729	0,926	0,567	7/16	0,567
R432002371	1/4	1,635	0,493	0,394	0,67	0,938	0,725	9/16	0,489
R432002374	5/16	1,635	0,571	0,394	0,729	1,052	0,725	9/16	0,567
R432002377	3/8	1,852	0,69	0,493	0,827	1,202	0,725	9/16	0,693
R432002372	1/4	1,852	0,571	0,496	0,67	1,036	0,867	3/4	0,489
R432002375	5/16	1,852	0,63	0,496	0,729	1,068	0,867	3/4	0,567
R432002378	3/8	2,049	0,749	0,611	0,827	1,217	0,867	3/4	0,693
R432002380	1/2	2,049	0,749	0,496	0,887	1,371	0,867	3/4	0,835
R432002376	5/16	2,049	0,682	0,611	0,729	1,143	1,103	1	0,567
R432002379	3/8	2,049	0,749	0,611	0,827	1,292	1,103	1	0,693
R432002381	1/2	2,049	0,749	0,611	0,887	1,43	1,103	1	0,835