

## AVENTICS Series QR1 Fittings

AVENTICS Series QR1 push-in connectors with easy, secure mounting are available in many versions: for tubing diameters from 3 to 16 mm, as well as in plastic, metal, and stainless steel variants. QR1 Series offers a cylindrical thread that allows repeated connection and release without problems (Quick Release) and captive O-ring guarantees an optimal sealing. Our QR program offers the right solution for every application and industry.



## Technical data

Industry	Industrial
Fitting type	Straight fitting with hexagon socket
Compressed air connection type	External thread
Port G	10-32 UNF
Compressed air connection type 2	push-in fitting
Port D	Ø1/8
Type	QR1-S-MIN
Min. working pressure	-0.95 bar
Max. working pressure	10 bar
Min. ambient temperature	0 °C
Max. ambient temperature	60 °C
Delivery unit	25 piece
Weight	0.005 kg

## Material

Surface	nickel-plated
Housing material	Brass
Surface housing	nickel-plated
Seal material	Acrylonitrile butadiene rubber

# Series QR1-S-MIN Mini

2024-05-17

R432000326

Material tooth lock washer	Stainless Steel
Material release ring	Polyoxymethylene
Material release ring holder	Die cast zinc Brass
Surface release ring holder	nickel-plated
Material thread	Brass
Surface thread	nickel-plated
Part No.	R432000326

## Technical information

The series QR1 (plastic) and QR2 (metal) can not be combined

Thread seal with captive O-ring

These pneumatic components with NPT or inch thread dimensions are only available from our US sales organization.

## Dimensions in inches

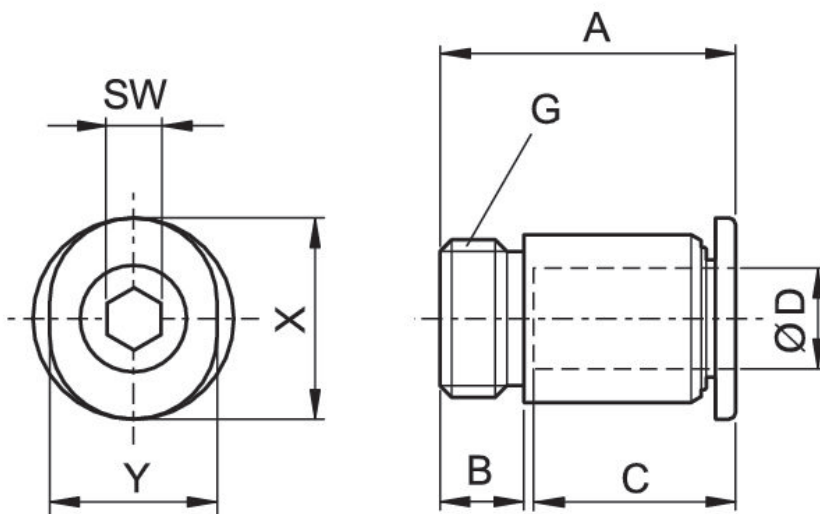

## Dimensions in inches

Part No.	Port D	Port G	A	B	C	SW	X	Y
R432000326	Ø1/8	10-32 UNF	0.6	0.14	0.41	3/32	0.28	0.24
R432000325	Ø1/8	1/8 NPT	0.56	0.32	0.41	3/32	0.28	0.24
R432000333	Ø5/32	10-32 UNF	0.63	0.14	0.44	3/32	0.39	0.32
R432000331	Ø5/32	1/8 NPT	0.6	0.32	0.44	3/32	0.39	0.32
R432000318	Ø1/4	10-32 UNF	0.7	0.14	0.46	3/32	0.47	0.39
R432000317	Ø1/4	1/8 NPT	0.74	0.32	0.46	5/32	0.47	0.39