

# Series QR1-S-MIN Mini

## R412005269

General series information  
AVENTICS Series QR1 Fittings

- AVENTICS Series QR1 push-in connectors with easy, secure mounting are available in many versions: for tubing diameters from 3 to 16 mm, as well as in plastic, metal, and stainless steel variants. QR1 Series offers a cylindric thread that allows repeated connection and release without problems (Quick Release) and captive O-ring guarantees an optimal sealing. Our QR program offers the right solution for every application and industry.



### Technical data

Industry	Industrial
Fitting type	Straight fitting with hexagon socket
Compressed air connection type	External thread
Port G	M6
Compressed air connection type 2	push-in fitting
Port D	Ø 3
Type	QR1-S-MIN
Working pressure min.	-0.95 bar
Working pressure max	10 bar
Min. ambient temperature	0 °C
Max. ambient temperature	60 °C
Delivery unit	25 piece
Weight	0.0042 kg

### Material

Surface	nickel-plated
Housing material	Brass
Surface housing	nickel-plated

Seal material	Acrylonitrile butadiene rubber
Material tooth lock washer	Stainless Steel
Material release ring	Polyoxymethylene
Material release ring holder	Die cast zinc Brass
Surface release ring holder	nickel-plated
Material thread	Brass
Surface thread	nickel-plated
Part No.	R412005269

### Technical information

The series QR1 (plastic) and QR2 (metal) can not be combined  
Thread seal with captive O-ring

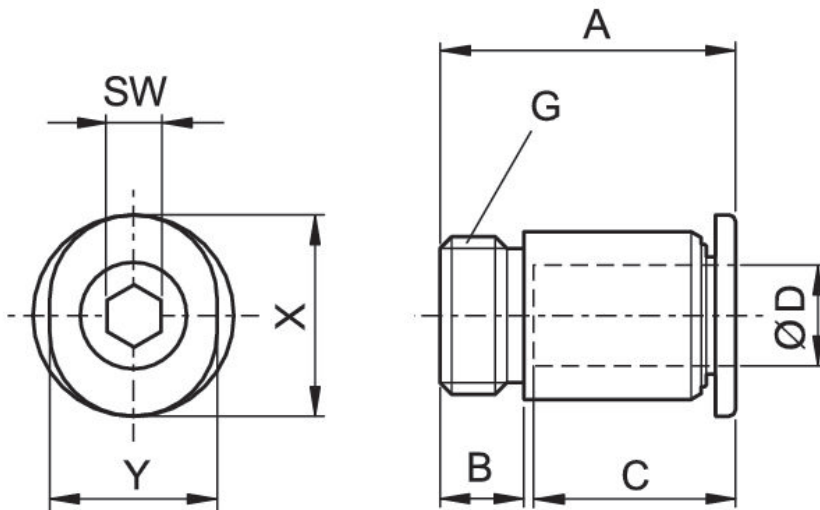

Part No.	Port D	Port G	A	B	C	SW	X	Y
R412005264	Ø 3	M3	15.9	3	9.5	1.5	7	6
R412005265	Ø 4	M3	18	3	11.5	1.5	10	8
R412005266	Ø 3	M5	18	4	9.5	2	7	6
R412005267	Ø 4	M5	16.3	4	11.5	2.5	10	8
R412005268	Ø 6	M5	17.8	4	12.5	2.5	12	10
R412005269	Ø 3	M6	20.2	5	9.5	3	7	6
R412005270	Ø 4	M6	20.2	5	11.5	3	10	8
R412005271	Ø 6	M6	18.8	5	12.5	3	12	10
R412005272	Ø 4	M7	21.4	5	11.5	3	10	8
R412005273	Ø 6	M7	20.1	5	12.5	3	12	10
R412005274	Ø 4	G 1/8	17	5	11.5	3	10	8
R412005275	Ø 6	G 1/8	20.6	5	12.5	4	12	10