

## AVENTICS Series QR1 Fittings

AVENTICS Series QR1 push-in connectors with easy, secure mounting are available in many versions: for tubing diameters from 3 to 16 mm, as well as in plastic, metal, and stainless steel variants. QR1 Series offers a cylindrical thread that allows repeated connection and release without problems (Quick Release) and captive O-ring guarantees an optimal sealing. Our QR program offers the right solution for every application and industry.

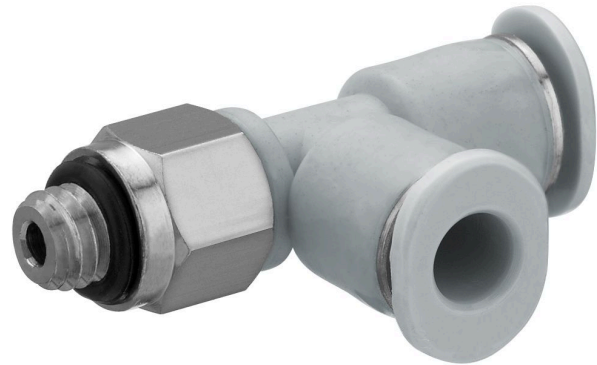

## Technical data

Industry	Industrial
Fitting type	Elbow fitting
Compressed air connection type	External thread
Port G	1/8 NPT
Compressed air connection type 2	push-in fitting
Port D	Ø1/4
Type	QR1-S-MLT
Min. working pressure	-0.95 bar
Max. working pressure	10 bar
Min. ambient temperature	0 °C
Max. ambient temperature	60 °C
Delivery unit	25 piece
Weight	0.009 kg

## Material

Surface	nickel-plated
Housing material	Polybutyleneterephthalate
Seal material	Acrylonitrile butadiene rubber
Material tooth lock washer	Stainless Steel

# Series QR1-S-MLT Mini

R432000307

Series QR1

2024-05-27

Material release ring	Polyoxymethylene
Material release ring holder	Die cast zinc Brass
Surface release ring holder	nickel-plated
Material thread	Brass
Surface thread	nickel-plated
Part No.	R432000307

## Technical information

The series QR1 (plastic) and QR2 (metal) can not be combined

Thread seal with captive O-ring

These pneumatic components with NPT or inch thread dimensions are only available from our US sales organization.

## Dimensions in inches

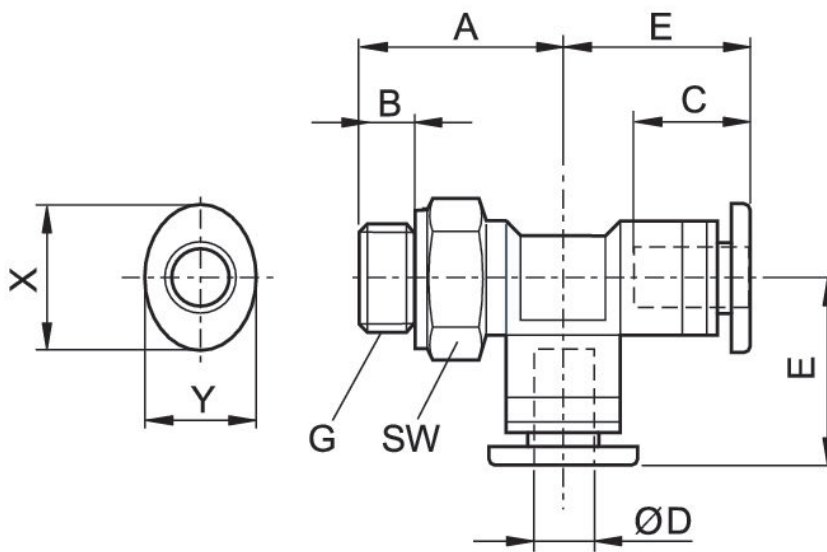

## Dimensions in inches

Part No.	Port D	Port G	A	B	C	E	SW	X	Y
R432000310	Ø1/8	10-32 UNF	0.98	0.14	0.36	0.43	5/16	0.28	0.24
R432000309	Ø1/8	1/8 NPT	1.06	0.32	0.36	0.43	13/32	0.28	0.24
R432000312	Ø5/32	10-32 UNF	0.98	0.14	0.7	0.54	5/16	0.39	0.32
R432000311	Ø5/32	1/8 NPT	1.03	0.32	0.7	0.54	13/32	0.39	0.32
R432000308	Ø1/4	10-32 UNF	1.02	0.14	0.47	0.58	5/16	0.47	0.39
R432000307	Ø1/4	1/8 NPT	1.18	0.31	0.47	0.58	13/32	0.47	0.39