

AVENTICS Series QR1 Fittings

AVENTICS Series QR1 push-in connectors with easy, secure mounting are available in many versions: for tubing diameters from 3 to 16 mm, as well as in plastic, metal, and stainless steel variants. QR1 Series offers a cylindrical thread that allows repeated connection and release without problems (Quick Release) and captive O-ring guarantees an optimal sealing. Our QR program offers the right solution for every application and industry.



Technical data

Industry	Industrial
Fitting type	Long elbow fitting
Compressed air connection type	External thread
Port G	1/8 NPT
Compressed air connection type 2	push-in fitting
Port D	Ø1/8
Type	QR1-S-MVL
Min. working pressure	-0.95 bar
Max. working pressure	10 bar
Min. ambient temperature	0 °C
Max. ambient temperature	60 °C
Delivery unit	25 piece
Weight	0.009 kg

Material

Surface	nickel-plated
Housing material	Polybutyleneterephthalate
Seal material	Acrylonitrile butadiene rubber
Material tooth lock washer	Stainless Steel

Series QR1-S-MVL Mini

R432000351

Series QR1

2024-05-27

Material release ring	Polyoxymethylene
Material release ring holder	Die cast zinc Brass
Surface release ring holder	nickel-plated
Material thread	Brass
Surface thread	nickel-plated
Part No.	R432000351

Technical information

The series QR1 (plastic) and QR2 (metal) can not be combined

Thread seal with captive O-ring

These pneumatic components with NPT or inch thread dimensions are only available from our US sales organization.

Dimensions in inches

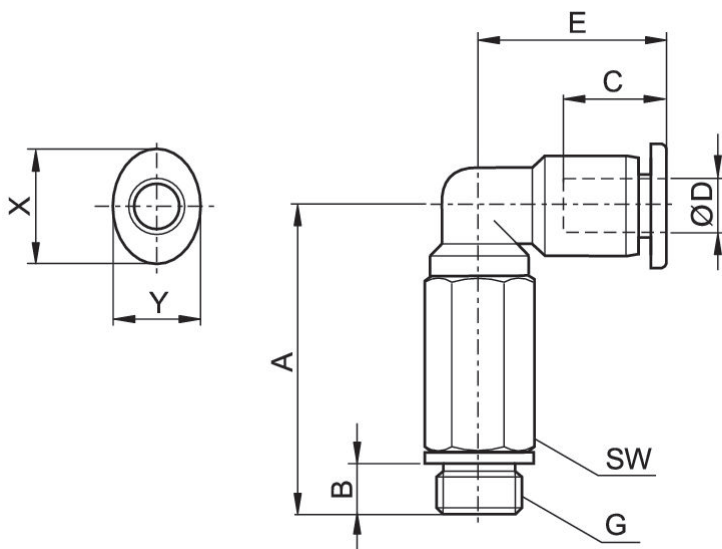

Dimensions in inches

Part No.	Port D	Port G	A	B	C	E	SW	X	Y
R432000352	Ø1/8	10-32 UNF	0.98	0.14	0.36	0.32	5/16	0.28	0.24
R432000351	Ø1/8	1/8 NPT	1.06	0.32	0.36	0.42	13/32	0.28	0.24
R432000354	Ø5/32	10-32 UNF	0.98	0.14	0.46	0.62	5/16	0.39	0.32
R432000353	Ø5/32	1/8 NPT	1.03	0.32	0.46	0.62	13/32	0.39	0.32
R432000350	Ø1/4	10-32 UNF	1.02	0.14	0.47	0.64	5/16	0.47	0.39
R432000349	Ø1/4	1/8 NPT	1.18	0.32	0.47	0.64	13/32	0.47	0.39