

## AVENTICS Series QR1 Fittings

AVENTICS Series QR1 push-in connectors with easy, secure mounting are available in many versions: for tubing diameters from 3 to 16 mm, as well as in plastic, metal, and stainless steel variants. QR1 Series offers a cylindrical thread that allows repeated connection and release without problems (Quick Release) and captive O-ring guarantees an optimal sealing. Our QR program offers the right solution for every application and industry.



## Technical data

Industry	Industrial
Fitting type	X-Plug connection
Compressed air connection type	push-in fitting
Port G	Ø1/8
Compressed air connection type 2	push-in fitting
Port D	Ø1/8
Type	QR1-S-MXS
Min. working pressure	-0.95 bar
Max. working pressure	10 bar
Min. ambient temperature	0 °C
Max. ambient temperature	60 °C
Delivery unit	25 piece
Weight	0.005 kg

## Material

Surface	nickel-plated
Housing material	Polybutyleneterephthalate
Seal material	Acrylonitrile butadiene rubber
Material tooth lock washer	Stainless Steel

# Series QR1-S-MXS Mini

R432000323

Series QR1

2024-05-27

Material release ring	Polyoxymethylene
Material release ring holder	Die cast zinc Brass
Surface release ring holder	nickel-plated
Part No.	R432000323

## Technical information

The series QR1 (plastic) and QR2 (metal) can not be combined

These pneumatic components with NPT or inch thread dimensions are only available from our US sales organization.

## Dimensions in inches

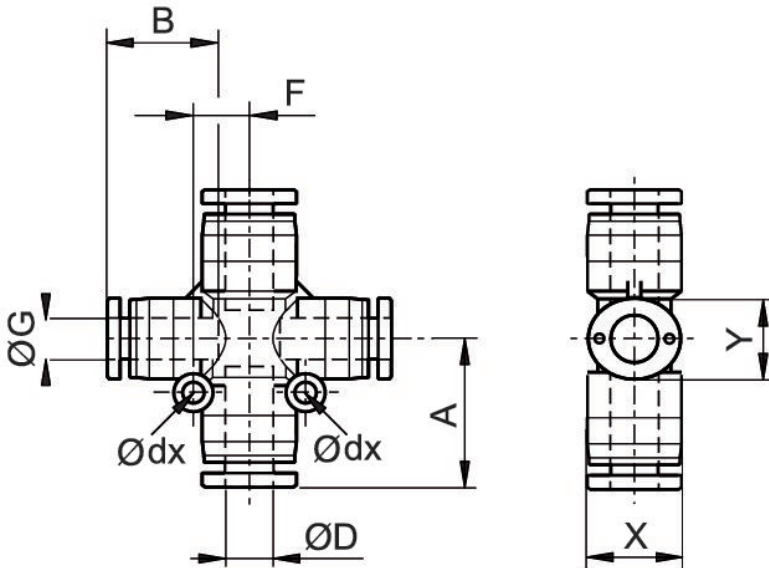

## Dimensions in inches

Part No.	Port D	Port G	Ø dx	A	B	F	X	Y
R432000315	Ø1/4	Ø1/4	0.13	0.75	0.36	0.28	0.24	0.01
R432000323	Ø1/8	Ø1/8	0.13	0.95	0.47	0.47	0.39	0.01