

QR1-S-RAI standard series

R432000019

General series information AVENTICS Series QR1 Fittings

- AVENTICS Series QR1 push-in connectors with easy, secure mounting are available in many versions: for tubing diameters from 3 to 16 mm, as well as in plastic, metal, and stainless steel variants. QR1 Series offers a cylindric thread that allows repeated connection and release without problems (Quick Release) and captive O-ring guarantees an optimal sealing. Our QR program offers the right solution for every application and industry.



Technical data

Industry	Industrial
Fitting type	Straight female stud fitting
Compressed air connection type	Internal thread
Port G	1/4 NPT
Compressed air connection type 2	push-in fitting
Port D	Ø1/4
Type	QR1-S-RAI
Working pressure min.	-0.95 bar
Working pressure max	10 bar
Min. ambient temperature	0 °C
Max. ambient temperature	60 °C
Delivery unit	10 piece
Weight	0.023 kg

Material

Surface	nickel-plated
Housing material	Brass
Surface housing	nickel-plated

Seal material	Acrylonitrile butadiene rubber
Material tooth lock washer	Stainless Steel
Material release ring	Polyoxymethylene
Material release ring holder	Die cast zinc Brass
Surface release ring holder	nickel-plated
Material thread	Brass
Surface thread	nickel-plated
Part No.	R432000019

Technical information

The series QR1 (plastic) and QR2 (metal) can not be combined

These pneumatic components with NPT or inch thread dimensions are only available from our US sales organization.

Dimensions in inches

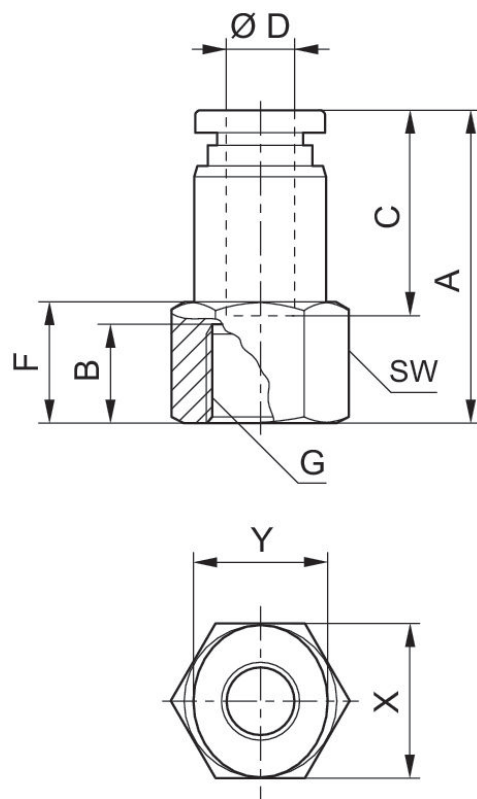

Dimensions in inches

Part No.	Port D	Port G	A	B	F	C	SW	X	Y
R432000030	$\varnothing 5/32$	1/8 NPT	1.01	0.36	0.43	0.63	9/16 "	0.47	0.39
R432000020	$\varnothing 1/4$	1/8 NPT	1.06	0.36	0.39	0.67	9/16 "	0.47	0.39

Part No.	Port D	Port G	A	B	F	C	SW	X	Y
R432000027	Ø5/16	1/8 NPT	1.13	0.36	0.47	0.73	9/16 "	0.63	0.55
R432000029	Ø5/32	1/4 NPT	1.13	0.47	0.55	0.63	11/16 "	0.47	0.39
R432000019	Ø1/4	1/4 NPT	1.18	0.47	0.55	0.67	11/16 "	0.47	0.39
R432000026	Ø5/16	1/4 NPT	1.23	0.47	0.59	0.73	11/16 "	0.63	0.55
R432000023	Ø 3/8	1/4 NPT	1.34	0.47	0.51	0.83	11/16 "	0.75	0.67
R432000017	Ø1/2	1/4 NPT	1.43	0.47	0.51	0.89	7/8 "	0.91	0.83
R432000021	Ø1/4	3/8 NPT	1.23	0.51	0.59	0.67	7/8 "	0.47	0.39
R432000028	Ø5/16	3/8 NPT	1.28	0.51	0.63	0.73	7/8 "	0.63	0.55
R432000024	Ø 3/8	3/8 NPT	1.38	0.51	0.59	0.83	7/8 "	0.75	0.67
R432000018	Ø1/2	3/8 NPT	1.47	0.51	0.55	0.89	7/8 "	0.91	0.83
R432000025	Ø5/16	1/2 NPT	1.4	0.63	0.75	0.73	7/8 "	0.63	0.55
R432000022	Ø 3/8	1/2 NPT	1.56	0.63	0.75	0.83	7/8 "	0.75	0.67
R432000016	Ø1/2	1/2 NPT	1.56	0.63	0.75	0.89	7/8 "	0.91	0.83