

# QR1-S-RAI standard series

R432000021

General series information  
AVENTICS Series QR1 Fittings

- AVENTICS Series QR1 push-in connectors with easy, secure mounting are available in many versions: for tubing diameters from 3 to 16 mm, as well as in plastic, metal, and stainless steel variants. QR1 Series offers a cylindric thread that allows repeated connection and release without problems (Quick Release) and captive O-ring guarantees an optimal sealing. Our QR program offers the right solution for every application and industry.

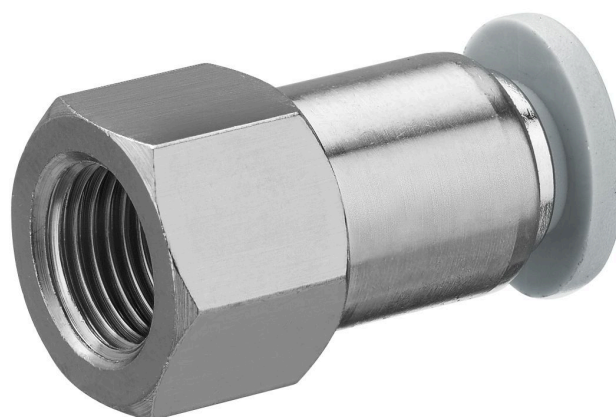

## Technical data

Industry	Industrial
Fitting type	Straight female stud fitting
Compressed air connection type	Internal thread
Port G	3/8 NPT
Compressed air connection type 2	push-in fitting
Port D	Ø1/4
Type	QR1-S-RAI
Working pressure min.	-0.95 bar
Working pressure max	10 bar
Min. ambient temperature	0 °C
Max. ambient temperature	60 °C
Delivery unit	10 piece
Weight	0.03 kg

## Material

Surface	nickel-plated
Housing material	Brass
Surface housing	nickel-plated

Seal material	Acrylonitrile butadiene rubber
Material tooth lock washer	Stainless Steel
Material release ring	Polyoxymethylene
Material release ring holder	Die cast zinc Brass
Surface release ring holder	nickel-plated
Material thread	Brass
Surface thread	nickel-plated
Part No.	R432000021

### Technical information

The series QR1 (plastic) and QR2 (metal) can not be combined

These pneumatic components with NPT or inch thread dimensions are only available from our US sales organization.

### Dimensions in inches

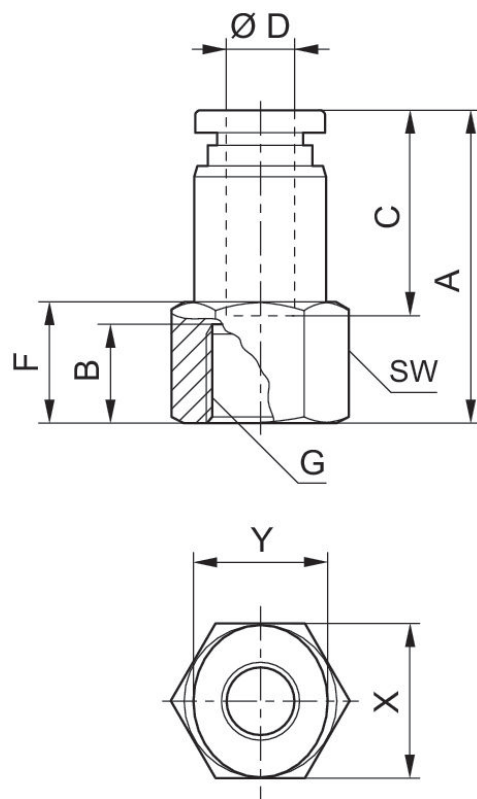

### Dimensions in inches

Part No.	Port D	Port G	A	B	F	C	SW	X	Y
R432000030	$\varnothing 5/32$	1/8 NPT	1.01	0.36	0.43	0.63	9/16 "	0.47	0.39
R432000020	$\varnothing 1/4$	1/8 NPT	1.06	0.36	0.39	0.67	9/16 "	0.47	0.39

Part No.	Port D	Port G	A	B	F	C	SW	X	Y
R432000027	Ø5/16	1/8 NPT	1.13	0.36	0.47	0.73	9/16 "	0.63	0.55
R432000029	Ø5/32	1/4 NPT	1.13	0.47	0.55	0.63	11/16 "	0.47	0.39
R432000019	Ø1/4	1/4 NPT	1.18	0.47	0.55	0.67	11/16 "	0.47	0.39
R432000026	Ø5/16	1/4 NPT	1.23	0.47	0.59	0.73	11/16 "	0.63	0.55
R432000023	Ø 3/8	1/4 NPT	1.34	0.47	0.51	0.83	11/16 "	0.75	0.67
R432000017	Ø1/2	1/4 NPT	1.43	0.47	0.51	0.89	7/8 "	0.91	0.83
R432000021	Ø1/4	3/8 NPT	1.23	0.51	0.59	0.67	7/8 "	0.47	0.39
R432000028	Ø5/16	3/8 NPT	1.28	0.51	0.63	0.73	7/8 "	0.63	0.55
R432000024	Ø 3/8	3/8 NPT	1.38	0.51	0.59	0.83	7/8 "	0.75	0.67
R432000018	Ø1/2	3/8 NPT	1.47	0.51	0.55	0.89	7/8 "	0.91	0.83
R432000025	Ø5/16	1/2 NPT	1.4	0.63	0.75	0.73	7/8 "	0.63	0.55
R432000022	Ø 3/8	1/2 NPT	1.56	0.63	0.75	0.83	7/8 "	0.75	0.67
R432000016	Ø1/2	1/2 NPT	1.56	0.63	0.75	0.89	7/8 "	0.91	0.83