

QR1-S-RAY standard series

R432000479

General series information
AVENTICS Series QR1 Fittings

- AVENTICS Series QR1 push-in connectors with easy, secure mounting are available in many versions: for tubing diameters from 3 to 16 mm, as well as in plastic, metal, and stainless steel variants. QR1 Series offers a cylindric thread that allows repeated connection and release without problems (Quick Release) and captive O-ring guarantees an optimal sealing. Our QR program offers the right solution for every application and industry.

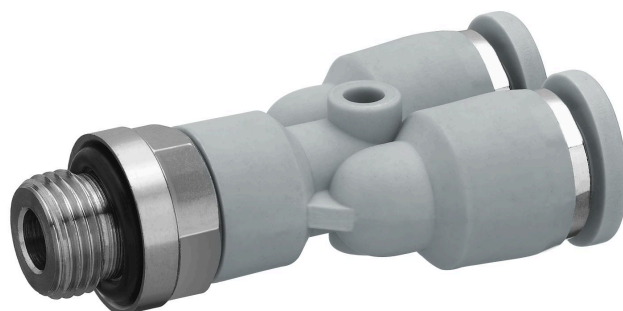

Technical data

Industry	Industrial
Fitting type	Y-fitting
Compressed air connection type	External thread
Port G	3/8 NPT
Compressed air connection type 2	push-in fitting
Port D	Ø1/4
Type	QR1-S-RAY
Working pressure min.	-0.95 bar
Working pressure max	10 bar
Min. ambient temperature	0 °C
Max. ambient temperature	60 °C
Delivery unit	10 piece
Weight	1.27 kg

Material

Surface	nickel-plated
Housing material	Polybutyleneterephthalate
Seal material	Acrylonitrile butadiene rubber

Material tooth lock washer	Stainless Steel
Material release ring	Polyoxymethylene
Material release ring holder	Die cast zinc Brass
Surface release ring holder	nickel-plated
Material thread	Brass
Surface thread	nickel-plated
Part No.	R432000479

Technical information

The series QR1 (plastic) and QR2 (metal) can not be combined

Thread seal with captive O-ring

These pneumatic components with NPT or inch thread dimensions are only available from our US sales organization.

Dimensions in inches

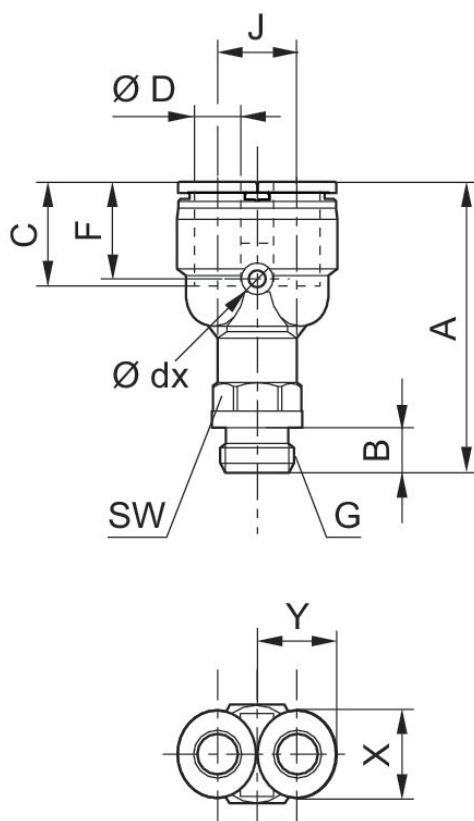

Dimensions in inches

Part No.	Port D	Port G	A	B	C	SW	J	X	Y
R432000473	Ø5/32	10-32 UNF	1.56	0.22	0.63	7/16	0.38	0.39	0.47

Part No.	Port D	Port G	A	B	C	SW	J	X	Y
R432000476	Ø1/4	10-32 UNF	1.64	0.22	0.67	1/2	0.47	0.47	0.55
R432000474	Ø5/32	1/8 NPT	1.66	0.32	0.63	7/16	0.38	0.39	0.47
R432000477	Ø1/4	1/8 NPT	1.72	0.32	0.67	1/2	0.47	0.47	0.55
R432000480	Ø5/16	1/8 NPT	1.88	0.22	0.73	9/16	0.55	0.55	0.63
R432000484	Ø 3/8	1/8 NPT	2.17	0.32	0.83	11/16	0.71	0.67	0.75
R432000475	Ø5/32	1/4 NPT	1.77	0.43	0.63	9/16	0.38	0.39	0.47
R432000481	Ø5/16	1/4 NPT	2.04	0.32	0.73	9/16	0.55	0.55	0.63
R432000478	Ø1/4	1/4 NPT	1.88	0.43	0.67	9/16	0.47	0.47	0.55
R432000485	Ø 3/8	1/4 NPT	2.29	0.43	0.83	11/16	0.71	0.67	0.75
R432000488	Ø1/2	1/4 NPT	2.39	0.43	0.89	7/8	0.82	0.83	0.91
R432000479	Ø1/4	3/8 NPT	1.96	0.47	0.67	11/16	0.47	0.47	0.55
R432000482	Ø5/16	3/8 NPT	2.08	0.43	0.73	11/16	0.55	0.55	0.63
R432000486	Ø 3/8	3/8 NPT	2.33	0.47	0.83	11/16	0.71	0.67	0.75
R432000489	Ø1/2	3/8 NPT	2.43	0.47	0.89	7/8	0.82	0.83	0.91
R432000483	Ø5/16	1/2 NPT	2.23	0.47	0.73	7/8	0.55	0.55	0.63
R432000487	Ø 3/8	1/2 NPT	2.45	0.59	0.83	7/8	0.71	0.67	0.75
R432000490	Ø1/2	1/2 NPT	2.55	0.59	0.89	7/8	0.82	0.83	0.91