

QR1-S-RID standard series

R432000074

General series information
AVENTICS Series QR1 Fittings

- AVENTICS Series QR1 push-in connectors with easy, secure mounting are available in many versions: for tubing diameters from 3 to 16 mm, as well as in plastic, metal, and stainless steel variants. QR1 Series offers a cylindric thread that allows repeated connection and release without problems (Quick Release) and captive O-ring guarantees an optimal sealing. Our QR program offers the right solution for every application and industry.



Technical data

Industry	Industrial
Fitting type	Swivel banjo connection 2-fold, with internal thread
Compressed air connection type	External thread
Port G	1/4 NPT
Compressed air connection type 2	push-in fitting
Port D	Ø5/16
Compressed air connection type 3	Internal thread
Compressed air connection 3	1/4 NPT
Type	QR1-S-RID
Working pressure min.	-0.95 bar
Working pressure max	10 bar
Min. ambient temperature	0 °C
Max. ambient temperature	60 °C
Weight	0.05 kg

Material

Surface	nickel-plated
Housing material	Polybutyleneterephthalate

Seal material	Acrylonitrile butadiene rubber
Material tooth lock washer	Stainless Steel
Material release ring	Polyoxymethylene
Material release ring holder	Die cast zinc Brass
Surface release ring holder	nickel-plated
Material thread	Brass
Surface thread	nickel-plated
Part No.	R432000074

Technical information

The series QR1 (plastic) and QR2 (metal) can not be combined

Thread seal with captive O-ring

These pneumatic components with NPT or inch thread dimensions are only available from our US sales organization.

Dimensions in inches

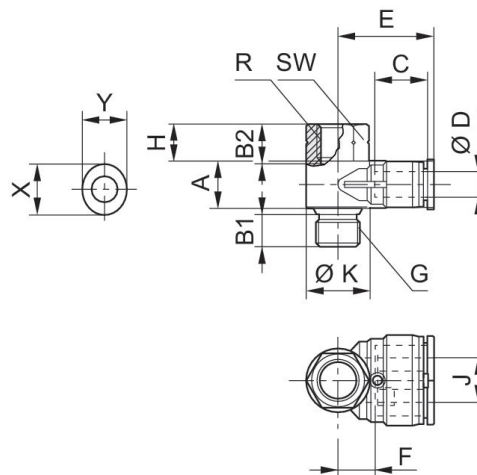

Dimensions in inches

Part No.	Port R	Port D	Port G	A	B1	B2	C	E	H
R432000075	10-32 UNF	Ø5/32	10-32 UNF	0.35	0.16	0.2	0.2	0.83	0.26
R432000072	1/4 NPT	Ø1/4	1/8 NPT	0.59	0.32	0.47	0.47	1.19	0.45
R432000074	1/4 NPT	Ø5/16	1/4 NPT	0.71	0.43	0.51	0.51	1.35	0.53
R432000073	3/8 NPT	Ø3/8	3/8 NPT	0.83	0.47	0.63	0.63	1.51	0.67
R432000071	1/2 NPT	Ø1/2	1/2 NPT	0.83	0.59	0.63	0.63	1.51	0.67

Part No.	J	Ø K	SW	X	Y
R432000075	0.39	0.39	5/16	0.47	0.39
R432000072	0.55	0.79	9/16	0.55	0.47
R432000074	0.67	0.91	11/16	0.63	0.55

Part No.	J	Ø K	SW	X	Y
R432000073	0.79	1.18	7/8	0.75	0.67
R432000071	0.79	1.18	1	0.91	0.83