

QR1-S-RMT standard series

R432000121

General series information
AVENTICS Series QR1 Fittings

- AVENTICS Series QR1 push-in connectors with easy, secure mounting are available in many versions: for tubing diameters from 3 to 16 mm, as well as in plastic, metal, and stainless steel variants. QR1 Series offers a cylindric thread that allows repeated connection and release without problems (Quick Release) and captive O-ring guarantees an optimal sealing. Our QR program offers the right solution for every application and industry.



Technical data

Industry	Industrial
Fitting type	Plug connector, 3x, reducing
Compressed air connection type	push-in fitting
Port G	Ø5/32
Compressed air connection type 2	push-in fitting
Port D	Ø5/16
Type	QR1-S-RMT
Working pressure min.	-0.95 bar
Working pressure max	10 bar
Min. ambient temperature	0 °C
Max. ambient temperature	60 °C
Delivery unit	10 piece
Weight	0.018 kg

Material

Surface	nickel-plated
Housing material	Polybutyleneterephthalate
Seal material	Acrylonitrile butadiene rubber

Material tooth lock washer	Stainless Steel
Material release ring	Polyoxymethylene
Material release ring holder	Die cast zinc
	Brass
Surface release ring holder	nickel-plated
Part No.	R432000121

Technical information

The series QR1 (plastic) and QR2 (metal) can not be combined

These pneumatic components with NPT or inch thread dimensions are only available from our US sales organization.

Dimensions in inches

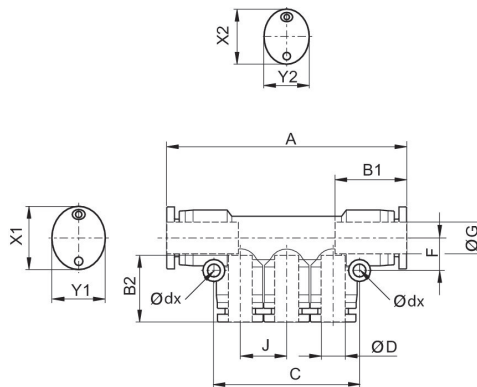

Dimensions in inches

Part No.	Port D	Port G	A	B1	B2	J	X1	Y1	X2
R432000121	Ø5/16	Ø5/32	2.44	0.73	0.63	0.39	0.63	0.55	0.47
R432000119	Ø5/16	Ø1/4	3.12	0.73	0.67	0.47	0.63	0.55	0.55
R432000122	Ø 3/8	Ø1/4	3.36	0.83	0.67	0.47	0.75	0.67	0.55
R432000118	Ø 3/8	Ø5/16	3.36	0.83	0.73	0.55	0.75	0.67	0.63

Part No.	Y2
R432000121	0.39
R432000119	0.47
R432000122	0.47
R432000118	0.55