

QR1-S-RSI standard series

2122606140

General series information
AVENTICS Series QR1 Fittings

- AVENTICS Series QR1 push-in connectors with easy, secure mounting are available in many versions: for tubing diameters from 3 to 16 mm, as well as in plastic, metal, and stainless steel variants. QR1 Series offers a cylindric thread that allows repeated connection and release without problems (Quick Release) and captive O-ring guarantees an optimal sealing. Our QR program offers the right solution for every application and industry.

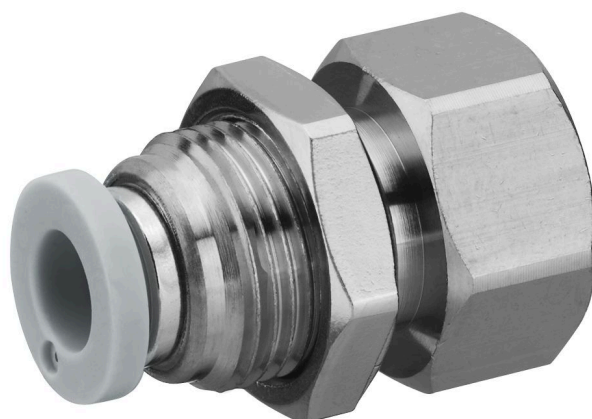

Technical data

Industry	Industrial
Fitting type	Bulkhead connector
Compressed air connection type	Internal thread
Port G	G 1/4
Compressed air connection type 2	push-in fitting
Port D	Ø 6
Type	QR1-S-RSI
Working pressure min.	-1 bar
Working pressure max	16 bar
Min. ambient temperature	-20 °C
Max. ambient temperature	80 °C
Min. medium temperature	-20 °C
Max. medium temperature	80 °C
Delivery unit	10 piece
Weight	0.028 kg

Material

Housing material	Brass
------------------	-------

Surface housing	nickel-plated
Seal material	Acrylonitrile butadiene rubber
Material tooth lock washer	Stainless Steel
Material release ring	Polyamide
Material release ring holder	Die cast zinc
Surface release ring holder	nickel-plated
Material thread	Brass
Surface thread	nickel-plated
Part No.	2122606140

Technical information

The series QR1 (plastic) and QR2 (metal) can not be combined

Dimensions in mm

