

QR1-S-RTT standard series

R432000182

General series information
AVENTICS Series QR1 Fittings

- AVENTICS Series QR1 push-in connectors with easy, secure mounting are available in many versions: for tubing diameters from 3 to 16 mm, as well as in plastic, metal, and stainless steel variants. QR1 Series offers a cylindric thread that allows repeated connection and release without problems (Quick Release) and captive O-ring guarantees an optimal sealing. Our QR program offers the right solution for every application and industry.

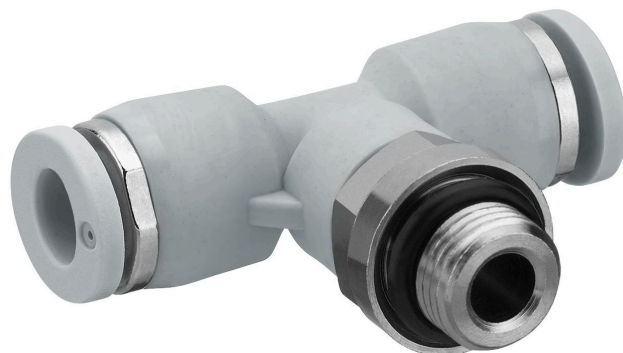

Technical data

Industry	Industrial
Fitting type	T-union
Compressed air connection type	External thread
Port G	1/4 NPT
Compressed air connection type 2	push-in fitting
Port D	Ø5/16
Type	QR1-S-RTT
Working pressure min.	-0.95 bar
Working pressure max	10 bar
Min. ambient temperature	0 °C
Max. ambient temperature	60 °C
Delivery unit	10 piece
Weight	0.06 kg

Material

Surface	nickel-plated
Housing material	Polybutyleneterephthalate
Seal material	Acrylonitrile butadiene rubber

Material tooth lock washer	Stainless Steel
Material release ring	Polyoxymethylene
Material release ring holder	Die cast zinc Brass
Surface release ring holder	nickel-plated
Material thread	Brass
Surface thread	nickel-plated
Part No.	R432000182

Technical information

The series QR1 (plastic) and QR2 (metal) can not be combined

Thread seal with captive O-ring

These pneumatic components with NPT or inch thread dimensions are only available from our US sales organization.

Dimensions

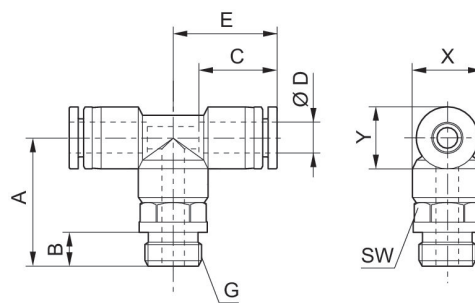

Dimensions in inches

Part No.	Port D	Port G	A	B	C	E	SW	X	Y
R432000171	Ø1/2	1/2 NPT	1.62	0.59	0.89	1.15	7/8	0.91	0.83
R432000172	Ø1/2	1/4 NPT	1.46	0.43	0.89	1.15	7/8	0.91	0.83
R432000173	Ø1/2	3/8 NPT	1.5	0.47	0.89	1.15	7/8	0.91	0.83
R432000174	Ø1/4	10-32 UNF	0.91	0.22	0.67	0.81	1/2	0.55	0.47
R432000175	Ø1/4	1/4 NPT	1.15	0.43	0.67	0.81	9/16	0.55	0.47
R432000176	Ø1/4	1/8 NPT	0.99	0.32	0.67	0.81	1/2	0.55	0.47
R432000177	Ø1/4	3/8 NPT	1.23	0.47	0.67	0.81	11/16	0.55	0.47
R432000178	Ø3/8	1/2 NPT	1.54	0.59	0.83	1.03	7/8	0.75	0.67
R432000179	Ø3/8	1/4 NPT	1.38	0.43	0.83	1.03	11/16	0.75	0.67
R432000180	Ø3/8	3/8 NPT	1.42	0.47	0.83	1.03	11/16	0.75	0.67
R432000181	Ø5/16	1/2 NPT	1.43	0.59	0.73	0.89	7/8	0.63	0.55
R432000182	Ø5/16	1/4 NPT	1.22	0.43	0.73	0.89	9/16	0.63	0.55
R432000183	Ø5/16	1/8 NPT	1.06	0.32	0.73	0.89	9/16	0.63	0.55
R432000184	Ø5/16	3/8 NPT	1.26	0.47	0.73	0.89	11/16	0.63	0.55
R432000185	Ø5/32	10-32 UNF	0.87	0.22	0.63	0.71	7/16	0.47	0.39

Part No.	Port D	Port G	A	B	C	E	SW	X	Y
R432000186	Ø5/32	1/4 NPT	1.09	0.43	0.63	0.71	9/16	0.47	0.39
R432000187	Ø5/32	1/8 NPT	0.97	0.32	0.63	0.71	7/16	0.47	0.39
R432000188	Ø5/32	3/8 NPT	1.13	0.47	0.63	0.71	11/16	0.47	0.39
R432002639	Ø3/8	1/8 NPT	1.26	0.32	0.83	1.03	11/16	0.75	0.67