

# QR1-S-RVL standard series

## R432000227

### General series information AVENTICS Series QR1 Fittings

- AVENTICS Series QR1 push-in connectors with easy, secure mounting are available in many versions: for tubing diameters from 3 to 16 mm, as well as in plastic, metal, and stainless steel variants. QR1 Series offers a cylindric thread that allows repeated connection and release without problems (Quick Release) and captive O-ring guarantees an optimal sealing. Our QR program offers the right solution for every application and industry.

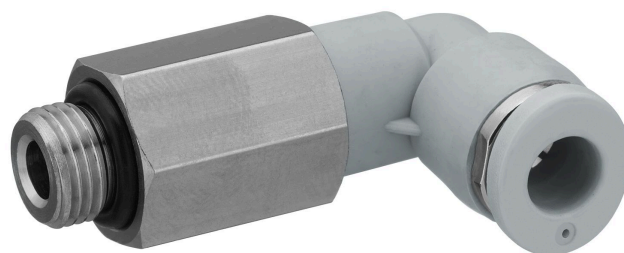

### Technical data

Industry	Industrial
Fitting type	Long elbow fitting
Compressed air connection type	External thread
Port G	1/4 NPT
Compressed air connection type 2	push-in fitting
Port D	Ø5/32
Type	QR1-S-RVL
Working pressure min.	-0.95 bar
Working pressure max	10 bar
Min. ambient temperature	0 °C
Max. ambient temperature	60 °C
Delivery unit	10 piece
Weight	0.032 kg

### Material

Surface	nickel-plated
Housing material	Polybutyleneterephthalate
Seal material	Acrylonitrile butadiene rubber

Material tooth lock washer	Stainless Steel
Material release ring	Polyoxymethylene
Material release ring holder	Die cast zinc Brass
Surface release ring holder	nickel-plated
Material thread	Brass
Surface thread	nickel-plated
Part No.	R432000227

### Technical information

The series QR1 (plastic) and QR2 (metal) can not be combined

Thread seal with captive O-ring

These pneumatic components with NPT or inch thread dimensions are only available from our US sales organization.

### Dimensions in inches

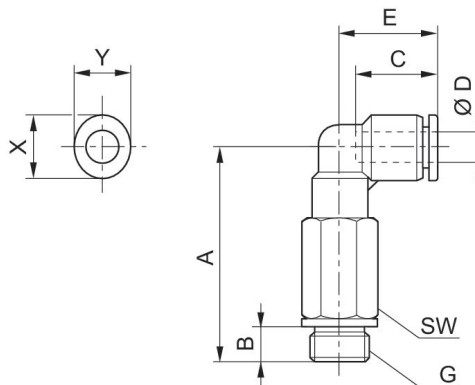

### Dimensions in inches

Part No.	Port D	Port G	A	B	C	E	SW	X	Y
R432000226	Ø5/32	10-32 UNF	1.19	0.22	0.63	0.71	5/16	0.47	0.39
R432000215	Ø1/4	10-32 UNF	1.24	0.22	0.67	0.81	5/16	0.55	0.47
R432000228	Ø5/32	1/8 NPT	1.28	0.32	0.63	0.71	7/16	0.47	0.39
R432000217	Ø1/4	1/8 NPT	1.33	0.32	0.67	0.81	7/16	0.55	0.47
R432000224	Ø5/16	1/8 NPT	1.46	0.32	0.73	0.9	7/16	0.63	0.55
R432002638	Ø5/32	1/8 NPT	1.99	0.32	0.83	1.03	11/16	0.67	0.75
R432000227	Ø5/32	1/4 NPT	1.4	0.43	0.63	0.71	9/16	0.47	0.39
R432000216	Ø1/4	1/4 NPT	1.44	0.43	0.67	0.81	9/16	0.55	0.47
R432000223	Ø5/16	1/4 NPT	1.54	0.43	0.73	0.9	9/16	0.63	0.55
R432000220	Ø3/8	1/4 NPT	1.96	0.43	0.83	1.03	19/32	0.75	0.67
R432000213	Ø1/2	1/4 NPT	2.03	0.43	0.89	1.15	19/32	0.91	0.83
R432000218	Ø1/4	3/8 NPT	1.5	0.47	0.67	0.81	11/16	0.55	0.47
R432000225	Ø5/16	3/8 NPT	1.99	0.47	0.73	0.9	11/16	0.63	0.55

Part No.	Port D	Port G	A	B	C	E	SW	X	Y
R432000221	Ø3/8	3/8 NPT	1.93	0.47	0.83	1.03	11/16	0.75	0.67
R432000214	Ø1/2	3/8 NPT	2	0.47	0.89	1.15	11/16	0.91	0.83
R432000219	Ø3/8	1/2 NPT	2.05	0.59	0.83	1.03	7/8	0.75	0.67
R432000212	Ø1/2	1/2 NPT	2.11	0.59	0.89	1.15	7/8	0.91	0.83