

2544404000

AVENTICS Series QR2 Fittings

AVENTICS Series QR2, push-in connectors with easy, secure mounting are available in many versions: In metal for tubing diameters from 3 to 16 mm. QR2 Series offers a cylindric thread that allows repeated connection and release without problems (Quick Release) and captive O-ring guarantees an optimal sealing. Our QR program offers the right solution for every application and industry.



Technical data

Industry	Industrial
Fitting type	Bulkhead push-in fitting, metal push-in fitting
Compressed air connection type	Ø 4
Port G	push-in fitting
Compressed air connection type 2	Ø 4
Port D	QR2-C-RSM
Type	suitable for use in food processing
suitable for use in food processing	-0.95 bar
Min. working pressure	16 bar
Max. working pressure	-20 °C
Min. ambient temperature	150 °C
Max. ambient temperature	2 piece
Delivery unit	0.024 kg
Weight	

Material

Housing material	Stainless Steel
Seal material	Fluorocautchouc
Material tooth lock washer	Stainless Steel

Series QR2-C-RSM, stainless steel

2024-04-10

2544404000

Material release ring

Stainless Steel

Part No.

2544404000

Technical information

The series QR1 (plastic) and QR2 (metal) can not be combined

Dimensions

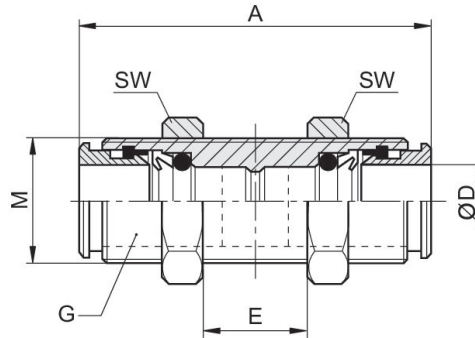

Part No.	Port D	Port G	M	A	C	E 1)	SW
2544404000	Ø 4	Ø 4	M12x1	27	13.5	11	15
2544406000	Ø 6	Ø 6	M14x1	32.5	16.2	16	17
2544408000	Ø 8	Ø 8	M16x1	33	16.5	17	19
2544410000	Ø 10	Ø 10	M18x1	37.5	18.7	19	21
2544412000	Ø 12	Ø 12	M20x1	39.5	19.7	20	24

1) max.