

AVENTICS Series QR2 Fittings

AVENTICS Series QR2, push-in connectors with easy, secure mounting are available in many versions: In metal for tubing diameters from 3 to 16 mm. QR2 Series offers a cylindric thread that allows repeated connection and release without problems (Quick Release) and captive O-ring guarantees an optimal sealing. Our QR program offers the right solution for every application and industry.



Technical data

Industry	Industrial
Fitting type	1x banjo union
Port G	G 1/8
Compressed air connection type 2	push-in fitting
Port D	Ø 8
Type	QR2-C-RV1
suitable for use in food processing	suitable for use in food processing
Min. working pressure	-0.95 bar
Max. working pressure	16 bar
Min. ambient temperature	-20 °C
Max. ambient temperature	150 °C
Delivery unit	2 piece
Weight	0.017 kg

Material

Housing material	Stainless Steel
Seal material	Fluorocautchouc
Material tooth lock washer	Stainless Steel
Material release ring	Stainless Steel

Series QR2-C-RV1, stainless steel

2024-04-10

R412004975

Part No.

R412004975

Technical information

The series QR1 (plastic) and QR2 (metal) can not be combined

Dimensions

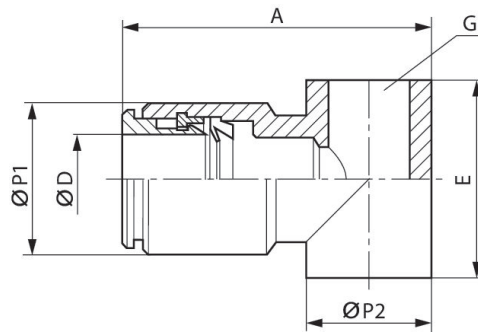

Part No.	Port D	Port G	A	E	Ø P1	Ø P2
R412004973	Ø 4	G 1/8	27	15	9	14
R412004974	Ø 6	G 1/8	29	15	12	14
R412004975	Ø 8	G 1/8	29.5	15	14	14
R412004976	Ø 6	G 1/4	32.5	17	12	18
R412004977	Ø 8	G 1/4	33	17	14	18