

2544204000

AVENTICS Series QR2 Fittings

AVENTICS Series QR2, push-in connectors with easy, secure mounting are available in many versions: In metal for tubing diameters from 3 to 16 mm. QR2 Series offers a cylindric thread that allows repeated connection and release without problems (Quick Release) and captive O-ring guarantees an optimal sealing. Our QR program offers the right solution for every application and industry.



Technical data

Industry	Industrial
Fitting type	Angled plug connector
Compressed air connection type	push-in fitting
Port G	Ø 4
Compressed air connection type 2	push-in fitting
Port D	Ø 4
Type	QR2-C-RVK
suitable for use in food processing	suitable for use in food processing
Min. working pressure	-0.95 bar
Max. working pressure	16 bar
Min. ambient temperature	-20 °C
Max. ambient temperature	150 °C
Delivery unit	2 piece
Weight	0.011 kg

Material

Housing material	Stainless Steel
Seal material	Fluorocautchouc
Material tooth lock washer	Stainless Steel

Series QR2-C-RVK, stainless steel

2024-04-10

2544204000

Material release ring

Stainless Steel

Part No.

2544204000

Technical information

The series QR1 (plastic) and QR2 (metal) can not be combined

Dimensions

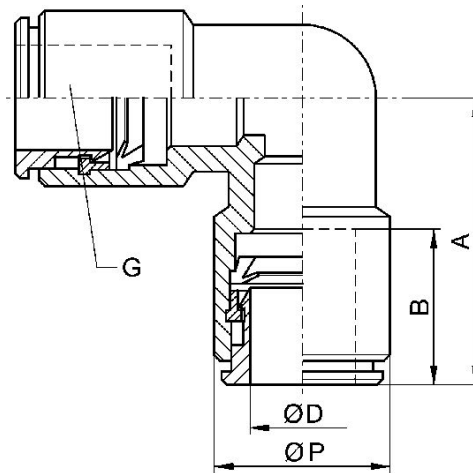

Part No.	Port D	Port G	A	B*	Ø P
2544204000	Ø 4	Ø 4	17	15	9
2544206000	Ø 6	Ø 6	20	16	12
2544208000	Ø 8	Ø 8	21	18	14
2544210000	Ø 10	Ø 10	25	19	16
2544212000	Ø 12	Ø 12	27	20	18

* Insertion depth