

## AVENTICS Series QR2 Fittings

AVENTICS Series QR2, push-in connectors with easy, secure mounting are available in many versions: In metal for tubing diameters from 3 to 16 mm. QR2 Series offers a cylindric thread that allows repeated connection and release without problems (Quick Release) and captive O-ring guarantees an optimal sealing. Our QR program offers the right solution for every application and industry.



## Technical data

Industry	Industrial
Fitting type	Straight fitting
Compressed air connection type	External thread
Port G	G 1/8
Compressed air connection type 2	push-in fitting
Port D	Ø 8
Type	QR2-F-RPN
Min. working pressure	-0.95 bar
Max. working pressure	16 bar
Min. ambient temperature	-20 °C
Max. ambient temperature	150 °C
Delivery unit	25 piece
Weight	0.012 kg

## Material

Housing material	Brass
Surface housing	nickel-plated
Seal material	Fluorocautchouc
Material tooth lock washer	Stainless Steel

# Series QR2-F-RPN Heat-resistant

2024-04-10

1823373093

Material release ring	Brass
Surface release ring	nickel-plated
Material thread	Brass
Surface thread	nickel-plated
Part No.	1823373093

## Technical information

The series QR1 (plastic) and QR2 (metal) can not be combined

Thread seal with captive O-ring

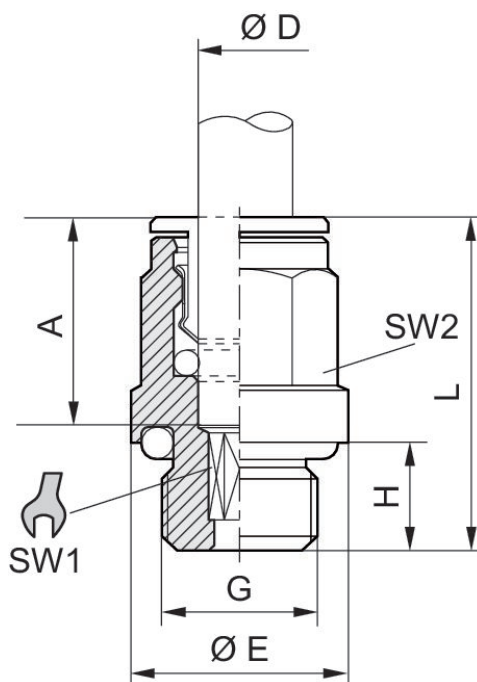

Part No.	Port D	Port G	Ø E	H	L	A Insertion depth	SW1	SW2
1823373089	Ø 4	M5	9	4	20.5	15	2.5	–
1823373090	Ø 6	M5	10.5	4	22.5	16	2.5	–
1823373091	Ø 4	G 1/8	13.5	6	20	15	2.5	9
1823373092	Ø 6	G 1/8	13.5	6	24	16	4	11
1823373093	Ø 8	G 1/8	13	6	26.5	18	5	13
1823373094	Ø 4	G 1/4	17	8	21	15	2.5	9
1823373095	Ø 6	G 1/4	17	6.5	22.5	15	4	11
1823373096	Ø 8	G 1/4	17	8	25	18	6	13
1823373097	Ø 10	G 1/4	16	8	29.5	19	7	16
R412007625	Ø 12	G 1/4	16	6.5	30	19	7	18
1823373098	Ø 8	G 3/8	20	9	25	18	6	13
1823373099	Ø 10	G 3/8	21	9	29.5	19	8	16

# Series QR2-F-RPN Heat-resistant

2024-04-10

1823373093

---

Part No.	Port D	Port G	Ø E	H	L	A Insertion depth	SW1	SW2
R412007730	Ø 12	G 1/2	24	11	31	20	10	18