

1823391863

## AVENTICS Series QR2 Fittings

AVENTICS Series QR2, push-in connectors with easy, secure mounting are available in many versions: In metal for tubing diameters from 3 to 16 mm. QR2 Series offers a cylindric thread that allows repeated connection and release without problems (Quick Release) and captive O-ring guarantees an optimal sealing. Our QR program offers the right solution for every application and industry.



## Technical data

Industry	Industrial
Fitting type	1x banjo union
Compressed air connection type	Internal thread
Port G	G 1/8
Compressed air connection type 2	push-in fitting
Port D	Ø 4
Type	QR2-F-RW1
Min. working pressure	-0.95 bar
Max. working pressure	16 bar
Min. ambient temperature	-20 °C
Max. ambient temperature	150 °C
Delivery unit	10 piece
Weight	0.01 kg

## Material

Housing material	Brass
Surface housing	nickel-plated
Seal material	Fluorocautchouc
Material tooth lock washer	Stainless Steel

# Series QR2-F-RW1 Heat-resistant

2024-04-10

1823391863

Material release ring

Brass

Surface release ring

nickel-plated

Part No.

1823391863

## Technical information

The series QR1 (plastic) and QR2 (metal) can not be combined

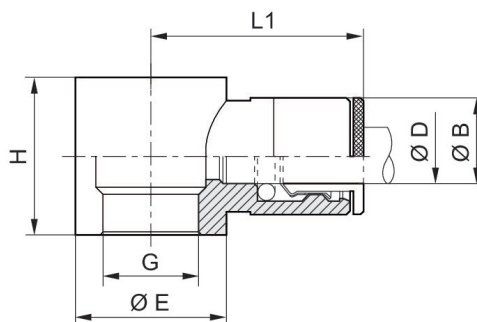

Part No.	Port D	Port G	Ø B	Ø E	H	L1
1823391862	Ø 4	M5	9	7	9	18.5
1823391863	Ø 4	G 1/8	9	14	15	21
1823391864	Ø 6	G 1/8	11	14	15	23
1823391865	Ø 8	G 1/8	13	14	15	24.5
1823391866	Ø 6	G 1/4	11	18	17	24
1823391867	Ø 8	G 1/4	13	18	17	26
1823391868	Ø 10	G 1/4	15	18	17	27