

## AVENTICS Series QR2 Fittings

AVENTICS Series QR2, push-in connectors with easy, secure mounting are available in many versions: In metal for tubing diameters from 3 to 16 mm. QR2 Series offers a cylindric thread that allows repeated connection and release without problems (Quick Release) and captive O-ring guarantees an optimal sealing. Our QR program offers the right solution for every application and industry.

## Technical data

Industry	Industrial
Fitting type	Push-in connector
Compressed air connection type	External thread
Port G	G 1/8
Compressed air connection type 2	pin bushing
Port D	Ø 6
Type	QR2-S-RAS
Min. working pressure	-0.95 bar
Max. working pressure	16 bar
Min. ambient temperature	-20 °C
Max. ambient temperature	80 °C
Delivery unit	25 piece
Weight	0.008 kg

## Material

Housing material	Brass
Surface housing	nickel-plated
Seal material	Acrylonitrile butadiene rubber
Material tooth lock washer	Stainless Steel
Material release ring	Brass
Surface release ring	nickel-plated
Material thread	Brass
Surface thread	nickel-plated
Part No.	1823373061

## Technical information

The series QR1 (plastic) and QR2 (metal) can not be combined

Thread seal with captive O-ring

# Series QR2-S-RAS standard

2024-04-10

1823373061

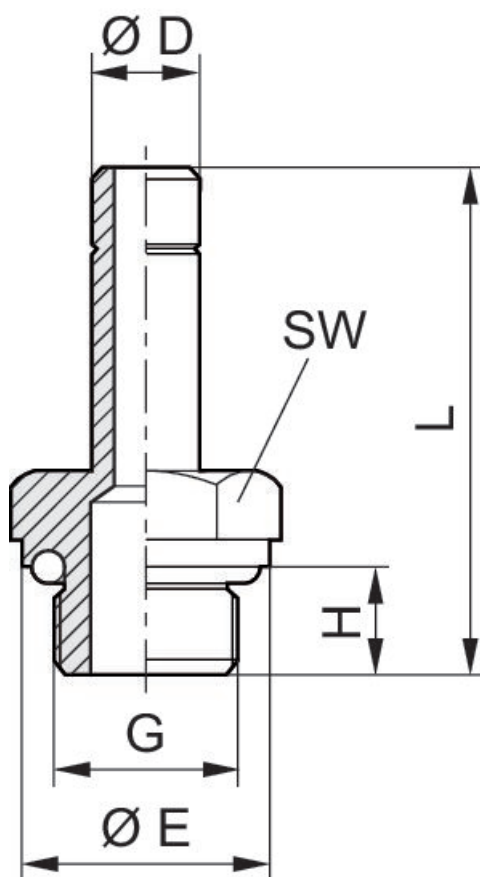

Part No.	Port D	Port G	$\varnothing E$	H	L	SW
1823373056	$\varnothing 4$	M5	8	4	24.5	8
1823373057	$\varnothing 5$	M5	8	4	25	8
1823373058	$\varnothing 6$	M5	8	4	26	8
1823373059	$\varnothing 4$	G 1/8	13	6	27.7	13
1823373060	$\varnothing 5$	G 1/8	13	6	28	13
1823373061	$\varnothing 6$	G 1/8	13	6	29.5	13
1823373062	$\varnothing 8$	G 1/8	13	6	31	13
1823373063	$\varnothing 4$	G 1/4	16	8	30.2	13
1823373064	$\varnothing 5$	G 1/4	16	8	31	13
1823373065	$\varnothing 6$	G 1/4	16	8	32	13
1823373066	$\varnothing 8$	G 1/4	16	8	33.5	13
1823373067	$\varnothing 10$	G 1/4	16	8	38	13
1823391810	$\varnothing 12$	G 1/4	16	8	39	13
1823373068	$\varnothing 8$	G 3/8	20	9	35.5	13
1823373069	$\varnothing 10$	G 3/8	20	9	41	13
1823373070	$\varnothing 12$	G 3/8	20	9	42	13
1823373071	$\varnothing 14$	G 3/8	20	9	44	16
1823373072	$\varnothing 12$	G 1/2	24	11	44	16
1823373073	$\varnothing 14$	G 1/2	24	11	46	16