

AVENTICS Series QR2 Fittings

AVENTICS Series QR2, push-in connectors with easy, secure mounting are available in many versions: In metal for tubing diameters from 3 to 16 mm. QR2 Series offers a cylindric thread that allows repeated connection and release without problems (Quick Release) and captive O-ring guarantees an optimal sealing. Our QR program offers the right solution for every application and industry.

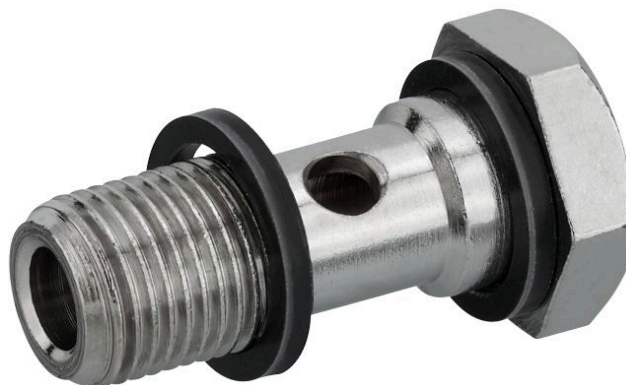

Technical data

Industry	Industrial
Fitting type	1x banjo bolt
Compressed air connection type	External thread
Port G	G 1/8
Type	QR2-S-RH1
Min. working pressure	-0.95 bar
Max. working pressure	16 bar
Min. ambient temperature	-20 °C
Max. ambient temperature	70 °C
Delivery unit	10 piece
Weight	0.004 kg

Material

Housing material	Brass
Surface housing	nickel-plated
Seal material	Polyvinyl chloride
Material tooth lock washer	Stainless Steel
Part No.	1823391575

Technical information

The series QR1 (plastic) and QR2 (metal) can not be combined

Only applicable in combination with QR2-S and NU2-S series banjo unions.

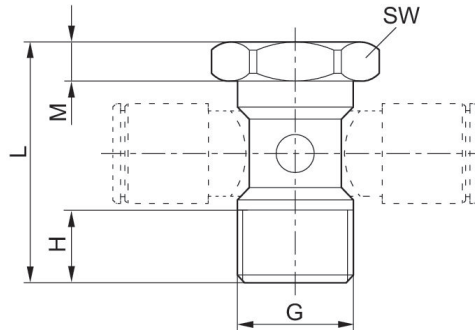

Part No.	Port G	H	L	M	SW
1823391574	M5	4.5	17.5	3	8
1823391575	G 1/8	9	28	4	14
1823391576	G 1/4	11	33	5	17
1823391577	G 3/8	12	36	4.5	19