

AVENTICS Series QR2 Fittings

AVENTICS Series QR2, push-in connectors with easy, secure mounting are available in many versions: In metal for tubing diameters from 3 to 16 mm. QR2 Series offers a cylindric thread that allows repeated connection and release without problems (Quick Release) and captive O-ring guarantees an optimal sealing. Our QR program offers the right solution for every application and industry.



Technical data

Industry	Industrial
Fitting type	Swivel banjo connection 1-fold, with hexagon socket rotatable
Compressed air connection type	External thread
Port G	M5
Compressed air connection type 2	push-in fitting
Port D	Ø 5
Type	QR2-S-RI1
Min. working pressure	-0.95 bar
Max. working pressure	16 bar
Min. ambient temperature	-20 °C
Max. ambient temperature	80 °C
Delivery unit	10 piece
Weight	0.016 kg

Material

Housing material	Brass
Surface housing	nickel-plated
Seal material	Acrylonitrile butadiene rubber

Series QR2-S-RI1 standard

2024-04-10

1823391653

Material tooth lock washer	Stainless Steel
Material release ring	Brass
Surface release ring	nickel-plated
Material thread	Brass
Surface thread	nickel-plated
Part No.	1823391653

Technical information

The series QR1 (plastic) and QR2 (metal) can not be combined

Thread seal with captive O-ring

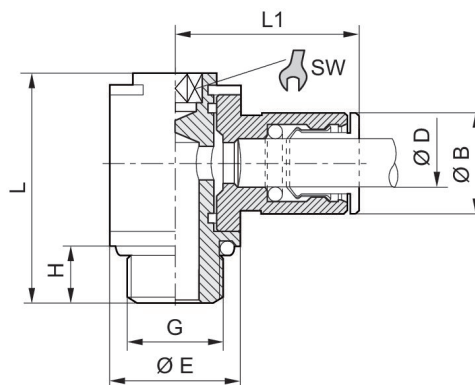

Part No.	Port D	Port G	Ø B	Ø E	H	L	L1	SW
1823391652	Ø 4	M5	9	8	4	17	18.5	2
1823391653	Ø 5	M5	10	8	4	17	19.5	2
1823391654	Ø 4	G 1/8	9	14	6	25	21	3
1823391655	Ø 5	G 1/8	10	14	6	25	22.5	3
1823391656	Ø 6	G 1/8	11	14	6	25	23	3
1823391657	Ø 8	G 1/8	13	14	6	25	24.5	3
1823391658	Ø 6	G 1/4	11	18	8	29.3	24	4
1823391659	Ø 8	G 1/4	13	18	8	29.3	26	4
1823391660	Ø 10	G 1/4	15	18	8	29.3	27	4
1823391927	Ø 12	G 1/4	17	18	8	29.3	28	4
1823391897	Ø 8	G 3/8	13	21	9	34	28	5
1823391898	Ø 10	G 3/8	15	21	9	34	29	5
1823391899	Ø 12	G 3/8	17	21	9	34	30	5