

## AVENTICS Series QR2 Fittings

AVENTICS Series QR2, push-in connectors with easy, secure mounting are available in many versions: In metal for tubing diameters from 3 to 16 mm. QR2 Series offers a cylindric thread that allows repeated connection and release without problems (Quick Release) and captive O-ring guarantees an optimal sealing. Our QR program offers the right solution for every application and industry.



## Technical data

Industry	Industrial
Fitting type	Elbow fitting rotatable
Compressed air connection type	External thread
Port G	G 1/4
Compressed air connection type 2	push-in fitting
Port D	Ø 12
Type	QR2-S-RLT
Min. working pressure	-0.95 bar
Max. working pressure	16 bar
Min. ambient temperature	-20 °C
Max. ambient temperature	80 °C
Delivery unit	5 piece
Weight	0.054 kg

## Material

Housing material	Brass
Surface housing	nickel-plated
Seal material	Acrylonitrile butadiene rubber

# Series QR2-S-RLT standard

2024-04-10

1823391836

Material tooth lock washer	Stainless Steel
Material release ring	Brass
Surface release ring	nickel-plated
Material thread	Brass
Surface thread	nickel-plated
Part No.	1823391836

## Technical information

The series QR1 (plastic) and QR2 (metal) can not be combined

Thread seal with captive O-ring

## Dimensions

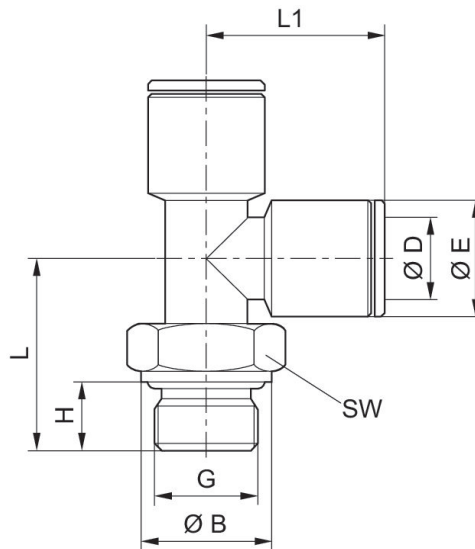

Part No.	Port D	Port G	Ø B	Ø E	H	L	L1	SW
1823391825	Ø 4	M5	8	9	4	20	19	9
1823391826	Ø 4	G 1/8	12.8	9	5.8	18.5	17.5	13
1823391827	Ø 6	G 1/8	12.8	11	5.8	18.5	21	13
1823391828	Ø 8	G 1/8	12.8	13	5.8	20.5	23	13
1823391829	Ø 4	G 1/4	15.8	9	8	22.5	19	16
1823391830	Ø 6	G 1/4	15.8	11	8	22.5	21	13
1823391831	Ø 8	G 1/4	15.8	13	8	22.5	24	13
1823391832	Ø 10	G 1/4	15.8	15	8	24.5	27	16
1823391836	Ø 12	G 1/4	15.8	17	8	24.5	27	16
1823391833	Ø 8	G 3/8	20	13	9	25.5	24	13
1823391834	Ø 10	G 3/8	20	15	9	24.5	25.5	16
1823391835	Ø 12	G 3/8	20	17	9	26.5	27	18
1823391837	Ø 14	G 1/2	25	20	11	30.5	31	21