

AVENTICS Series QR2 Fittings

AVENTICS Series QR2, push-in connectors with easy, secure mounting are available in many versions: In metal for tubing diameters from 3 to 16 mm. QR2 Series offers a cylindric thread that allows repeated connection and release without problems (Quick Release) and captive O-ring guarantees an optimal sealing. Our QR program offers the right solution for every application and industry.

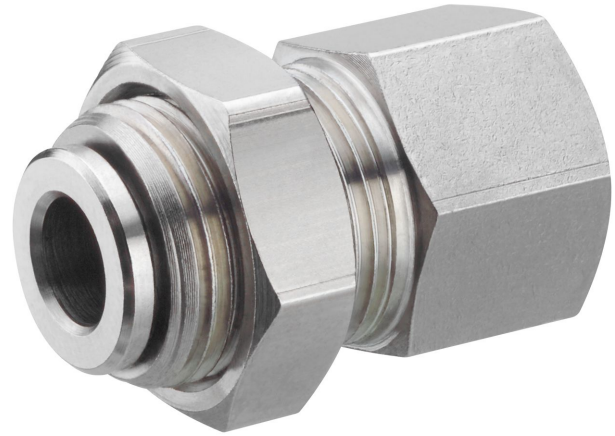

Technical data

Industry	Industrial
Fitting type	Bulkhead connector
Compressed air connection type	Internal thread
Port G	G 1/8
Compressed air connection type 2	push-in fitting
Port D	Ø 6
Type	QR2-S-RSI
Min. working pressure	-0.95 bar
Max. working pressure	16 bar
Min. ambient temperature	-20 °C
Max. ambient temperature	80 °C
Delivery unit	10 piece

Material

Housing material	Brass
Surface housing	nickel-plated
Seal material	Acrylonitrile butadiene rubber
Material tooth lock washer	Stainless Steel
Material release ring	Brass

Series QR2-S-RSI standard

2024-04-10

1823391758

Surface release ring	nickel-plated
Material thread	Brass
Surface thread	nickel-plated
Part No.	1823391758

Technical information

The series QR1 (plastic) and QR2 (metal) can not be combined

Dimensions

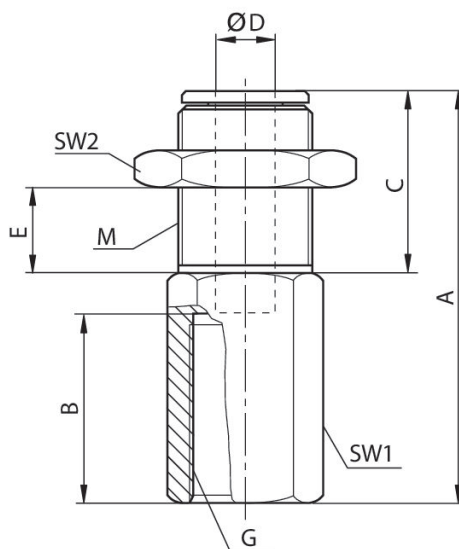

Part No.	Port D	Port G	M	A	B	C	E ±2 max.	SW1	SW2
1823391757	Ø 4	G 1/8	M10x1	25	8.5	15	9.5	15	13
1823391758	Ø 6	G 1/8	M14x1	26	8.5	15	9.5	17	17
1823391759	Ø 6	G 1/4	M14x1	30.5	13	15	9.5	17	17
1823391760	Ø 8	G 1/8	M16x1	28	8.5	15	9.5	17	19
1823391761	Ø 8	G 1/4	M16x1	33	13	15	9.5	17	19