

## AVENTICS Series QR2 Fittings

AVENTICS Series QR2, push-in connectors with easy, secure mounting are available in many versions: In metal for tubing diameters from 3 to 16 mm. QR2 Series offers a cylindric thread that allows repeated connection and release without problems (Quick Release) and captive O-ring guarantees an optimal sealing. Our QR program offers the right solution for every application and industry.



## Technical data

Industry	Industrial
Fitting type	T-banjo connection with hexagon socket rotatable
Compressed air connection type	External thread
Port G	G 3/8
Compressed air connection type 2	push-in fitting
Port D	Ø 8
Type	QR2-S-RTI
Min. working pressure	-0.95 bar
Max. working pressure	16 bar
Min. ambient temperature	-20 °C
Max. ambient temperature	80 °C
Delivery unit	2 piece
Weight	0.056 kg

## Material

Housing material	Brass
Surface housing	nickel-plated
Seal material	Acrylonitrile butadiene rubber

# Series QR2-S-RTI standard

2024-04-10

1823391900

Material tooth lock washer	Stainless Steel
Material release ring	Brass
Surface release ring	nickel-plated
Material thread	Brass
Surface thread	nickel-plated
Part No.	1823391900

## Technical information

The series QR1 (plastic) and QR2 (metal) can not be combined

Thread seal with captive O-ring

## Dimensions

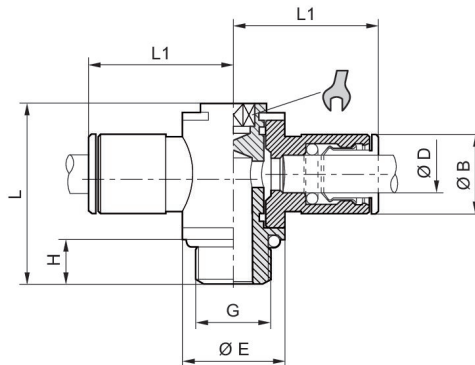

Part No.	Port D	Port G	L	L1	H	Ø B	Ø E	SW
1823391661	Ø 4	M5	17	18.5	4	9	8	2
1823391662	Ø 5	M5	17	19.5	4	10	8	2
1823391663	Ø 4	G 1/8	25	21	6	9	14	3
1823391664	Ø 5	G 1/8	25	22.5	6	10	14	3
1823391665	Ø 6	G 1/8	25	23	6	11	14	3
1823391666	Ø 8	G 1/8	25	24.5	6	13	14	3
1823391667	Ø 6	G 1/4	29.3	24	8	11	18	4
1823391668	Ø 8	G 1/4	29.3	26	8	13	18	4
1823391669	Ø 10	G 1/4	29.3	27	8	15	18	4
1823391900	Ø 8	G 3/8	34	28	9	13	21	5
1823391901	Ø 10	G 3/8	34	29	9	15	21	5
1823391902	Ø 12	G 3/8	34	29	9	17	21	5