

AVENTICS Series QR2 Fittings

AVENTICS Series QR2, push-in connectors with easy, secure mounting are available in many versions: In metal for tubing diameters from 3 to 16 mm. QR2 Series offers a cylindric thread that allows repeated connection and release without problems (Quick Release) and captive O-ring guarantees an optimal sealing. Our QR program offers the right solution for every application and industry.



Technical data

Industry	Industrial
Fitting type	1x banjo union
Port G	G 1/4
Compressed air connection type 2	push-in fitting
Port D	Ø 6
Type	QR2-S-RV1
Min. working pressure	-0.95 bar
Max. working pressure	16 bar
Min. ambient temperature	-20 °C
Max. ambient temperature	80 °C
Delivery unit	10 piece
Weight	0.018 kg

Material

Housing material	Brass
Surface housing	nickel-plated
Seal material	Acrylonitrile butadiene rubber
Material tooth lock washer	Stainless Steel
Material release ring	Brass

Series QR2-S-RV1 standard

2024-04-10

1823391589

Surface release ring

nickel-plated

Part No.

1823391589

Technical information

The series QR1 (plastic) and QR2 (metal) can not be combined

Dimensions

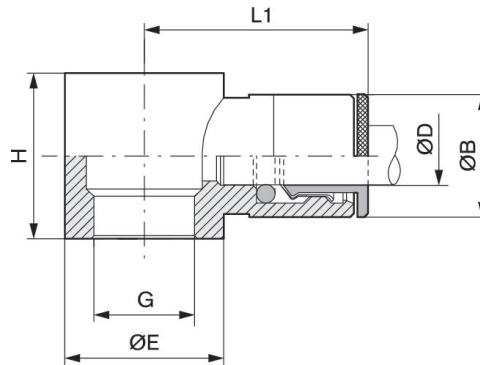

Part No.	Port D	Port G	Ø B	Ø E	H	L1
1823391583	Ø 4	M5	9	8.2	9	18.5
1823391584	Ø 5	M5	10	7	9	19.5
1823391585	Ø 4	G 1/8	9	14	15	21
1823391586	Ø 5	G 1/8	10	14	15	22.5
1823391587	Ø 6	G 1/8	11	14	15	23
1823391588	Ø 8	G 1/8	13	14	15	24.5
1823391589	Ø 6	G 1/4	11	18	17	24
1823391590	Ø 8	G 1/4	13	18	17	26
1823391591	Ø 10	G 1/4	15	18	17	27
1823391592	Ø 8	G 3/8	13	21	20	28
1823391593	Ø 10	G 3/8	15	21	20	29
1823391594	Ø 12	G 3/8	17	21	20	30