

AVENTICS Series QR2 Fittings

AVENTICS Series QR2, push-in connectors with easy, secure mounting are available in many versions: In metal for tubing diameters from 3 to 16 mm. QR2 Series offers a cylindric thread that allows repeated connection and release without problems (Quick Release) and captive O-ring guarantees an optimal sealing. Our QR program offers the right solution for every application and industry.



Technical data

Industry	Industrial
Fitting type	Angled plug connector
Compressed air connection type	push-in fitting
Port G	Ø 4
Compressed air connection type 2	push-in fitting
Port D	Ø 4
Type	QR2-S-RVK
Min. working pressure	-0.95 bar
Max. working pressure	16 bar
Min. ambient temperature	-20 °C
Max. ambient temperature	80 °C
Delivery unit	10 piece
Weight	0.01 kg

Material

Housing material	Brass
Surface housing	nickel-plated
Seal material	Acrylonitrile butadiene rubber
Material tooth lock washer	Stainless Steel

Series QR2-S-RVK standard

2024-04-10

1823380012

Material release ring

Brass

Surface release ring

nickel-plated

Part No.

1823380012

Technical information

The series QR1 (plastic) and QR2 (metal) can not be combined

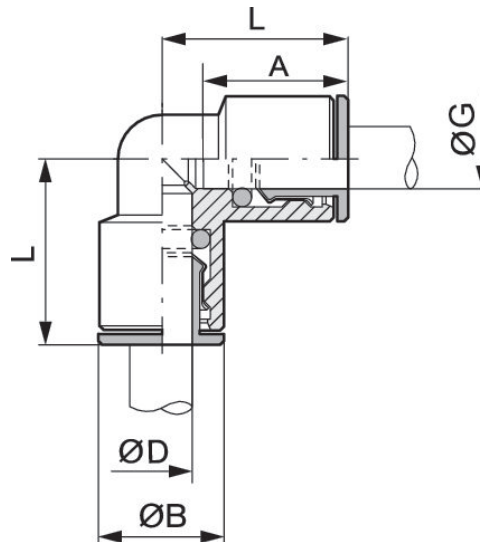

Part No.	Port D	Port G	ØB	L	A Insertion depth
1823380012	Ø 4	Ø 4	9	17.5	14
1823380013	Ø 5	Ø 5	9.5	19	16
1823380014	Ø 6	Ø 6	11	19.5	16
1823380015	Ø 8	Ø 8	13	23	18
1823380016	Ø 10	Ø 10	15	25	19
1823380017	Ø 12	Ø 12	17	27	20
1823380018	Ø 14	Ø 14	19	30	22
R412010540	Ø 16	Ø 16	23	33	36