

## AVENTICS Series QR2 Fittings

AVENTICS Series QR2, push-in connectors with easy, secure mounting are available in many versions: In metal for tubing diameters from 3 to 16 mm. QR2 Series offers a cylindric thread that allows repeated connection and release without problems (Quick Release) and captive O-ring guarantees an optimal sealing. Our QR program offers the right solution for every application and industry.



## Technical data

Industry	Industrial
Fitting type	Angled plug connector
Compressed air connection type	push-in fitting
Port G	Ø 6
Compressed air connection type 2	push-in fitting
Port D	Ø 6
Type	QR2-S-RVK
Min. working pressure	-0.95 bar
Max. working pressure	16 bar
Min. ambient temperature	-20 °C
Max. ambient temperature	80 °C
Delivery unit	10 piece
Weight	0.014 kg

## Material

Housing material	Brass
Surface housing	nickel-plated
Seal material	Acrylonitrile butadiene rubber
Material tooth lock washer	Stainless Steel

# Series QR2-S-RVK standard

2024-04-10

1823380014

Material release ring  
Surface release ring  
Part No.

Brass  
nickel-plated  
1823380014

## Technical information

The series QR1 (plastic) and QR2 (metal) can not be combined

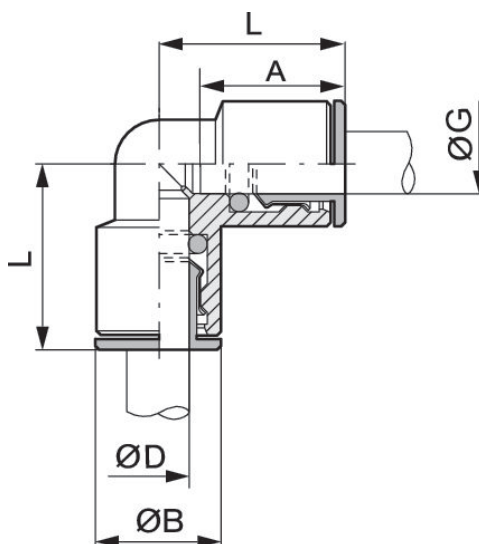

Part No.	Port D	Port G	ØB	L	A Insertion depth
1823380012	Ø 4	Ø 4	9	17.5	14
1823380013	Ø 5	Ø 5	9.5	19	16
1823380014	Ø 6	Ø 6	11	19.5	16
1823380015	Ø 8	Ø 8	13	23	18
1823380016	Ø 10	Ø 10	15	25	19
1823380017	Ø 12	Ø 12	17	27	20
1823380018	Ø 14	Ø 14	19	30	22
R412010540	Ø16	Ø16	23	33	36