

## AVENTICS Series QR2 Fittings

AVENTICS Series QR2, push-in connectors with easy, secure mounting are available in many versions: In metal for tubing diameters from 3 to 16 mm. QR2 Series offers a cylindric thread that allows repeated connection and release without problems (Quick Release) and captive O-ring guarantees an optimal sealing. Our QR program offers the right solution for every application and industry.



## Technical data

Industry	Industrial
Fitting type	Long elbow fitting rotatable
Compressed air connection type	External thread
Port G	G 1/4
Compressed air connection type 2	push-in fitting
Port D	Ø 8
Type	QR2-S-RVL
Min. working pressure	-0.95 bar
Max. working pressure	16 bar
Min. ambient temperature	-20 °C
Max. ambient temperature	80 °C
Delivery unit	10 piece
Weight	0.039 kg

## Material

Housing material	Brass
Surface housing	nickel-plated
Seal material	Acrylonitrile butadiene rubber

# Series QR2-S-RVL standard

2024-04-10

R412010274

Material tooth lock washer	Stainless Steel
Material release ring	Brass
Surface release ring	nickel-plated
Material thread	Brass
Surface thread	nickel-plated
Part No.	R412010274

## Technical information

The series QR1 (plastic) and QR2 (metal) can not be combined

Thread seal with captive O-ring

## Dimensions

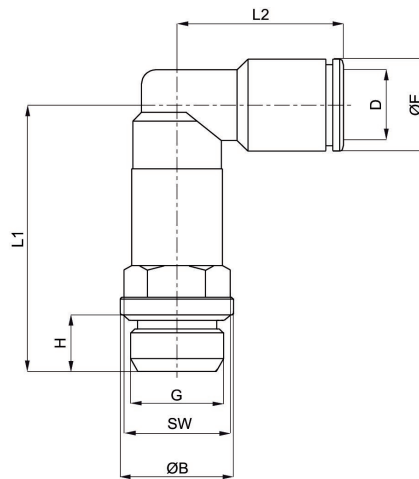

Part No.	Port D	Port G	ØB	ØE	H	L1	L2	SW
R412010270	Ø 4	G 1/8	13	9	6	33	20	13
R412010271	Ø 6	G 1/8	13	11	6	33	21.5	13
R412010272	Ø 8	G 1/8	13	13	6	33	23.5	13
R412010273	Ø 6	G 1/4	16	11	8	37.7	21.5	13
R412010274	Ø 8	G 1/4	16	13	8	37.7	23.5	13
R412010275	Ø 10	G 1/4	16	15	8	40	26,5	16