

## AVENTICS Series QR2 Fittings

AVENTICS Series QR2, push-in connectors with easy, secure mounting are available in many versions: In metal for tubing diameters from 3 to 16 mm. QR2 Series offers a cylindric thread that allows repeated connection and release without problems (Quick Release) and captive O-ring guarantees an optimal sealing. Our QR program offers the right solution for every application and industry.



## Technical data

Industry	Industrial
Fitting type	Elbow fitting rotatable
Compressed air connection type	External thread
Port G	G 3/8
Compressed air connection type 2	push-in fitting
Port D	Ø 14
Type	QR2-S-RVT
Min. working pressure	-0.95 bar
Max. working pressure	16 bar
Min. ambient temperature	-20 °C
Max. ambient temperature	80 °C
Delivery unit	5 piece
Weight	0.062 kg

## Material

Housing material	Brass
Surface housing	nickel-plated
Seal material	Acrylonitrile butadiene rubber

# Series QR2-S-RVT standard

2024-04-10

1823391839

Material tooth lock washer	Stainless Steel
Material release ring	Brass
Surface release ring	nickel-plated
Material thread	Brass
Surface thread	nickel-plated
Part No.	1823391839

## Technical information

The series QR1 (plastic) and QR2 (metal) can not be combined

Thread seal with captive O-ring

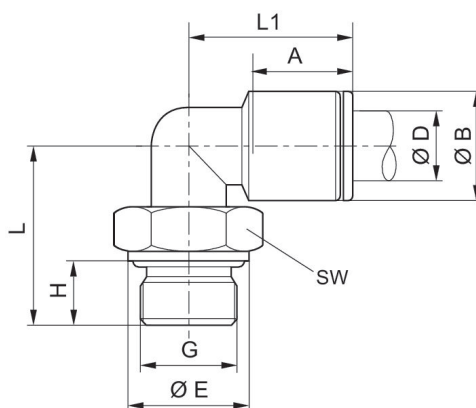

Part No.	Port D	Port G	ØB	ØE	H	L	L1	A Insertion depth	SW
1823391709	Ø 4	M5	9	8	4	14.5	19	14	9
1823391889	Ø 6	M5	11	8	4	14.5	21	16	9
1823391885	Ø 4	M7	9	10	6	16.5	18	14	9
1823391886	Ø 6	M7	11	10	6	16.5	19.5	16	9
1823391710	Ø 4	G 1/8	9	13	6	20	19	15	13
1823391711	Ø 6	G 1/8	11	13	6	20	21	16	13
1823391712	Ø 8	G 1/8	13	13	6	20	24	18	13
R412007687	Ø 10	G 1/8	15	13	6	24	27	19	13
1823391713	Ø 4	G 1/4	9	16	8	24	19	15	13
1823391714	Ø 6	G 1/4	11	16	8	24	21	16	13
1823391715	Ø 8	G 1/4	13	16	8	24	24	18	13
1823391718	Ø 10	G 1/4	15	16	8	24	27	19	16
1823391843	Ø 12	G 1/4	17	16	8	30.5	29	20	16
1823391716	Ø 8	G 3/8	13	20	9	25.5	24	18	13
1823391717	Ø 10	G 3/8	15	20	9	28	27	19	16
1823391838	Ø 12	G 3/8	17	20	9	28.5	28	20	20
1823391839	Ø 14	G 3/8	20	20	9	28.5	31	22	20
R412010182	Ø16	G 3/8	23	20	9	33.5	33	23.5	20

# Series QR2-S-RVT standard

2024-04-10

1823391839

Part No.	Port D	Port G	ØB	ØE	H	L	L1	A Insertion depth	SW
R412007589	Ø 10	G 1/2	15	25	11	30	27	19	16
1823391840	Ø 12	G 1/2	17	25	11	33.5	28	20	20
1823391841	Ø 14	G 1/2	20	25	11	33.5	31	22	20
R412007956	Ø16	G 1/2	23	25	11	38	33	23.5	20