

AVENTICS Series QR2 Fittings

AVENTICS Series QR2, push-in connectors with easy, secure mounting are available in many versions: In metal for tubing diameters from 3 to 16 mm. QR2 Series offers a cylindric thread that allows repeated connection and release without problems (Quick Release) and captive O-ring guarantees an optimal sealing. Our QR program offers the right solution for every application and industry.



Technical data

Industry	Industrial
Fitting type	Swivel banjo connection 1-fold
Compressed air connection type	External thread
Port G	G 3/8
Compressed air connection type 2	push-in fitting
Port D	Ø 12
Type	QR2-S-RW1
Min. working pressure	-0.95 bar
Max. working pressure	16 bar
Min. ambient temperature	-20 °C
Max. ambient temperature	80 °C
Delivery unit	5 piece
Weight	0.088 kg

Material

Housing material	Brass
Surface housing	nickel-plated
Seal material	Acrylonitrile butadiene rubber
Material tooth lock washer	Stainless Steel

Series QR2-S-RW1 standard

2024-04-10

1823391561

Material release ring	Brass
Surface release ring	nickel-plated
Material thread	Brass
Surface thread	nickel-plated
Part No.	1823391561

Technical information

The series QR1 (plastic) and QR2 (metal) can not be combined

Thread seal with captive O-ring

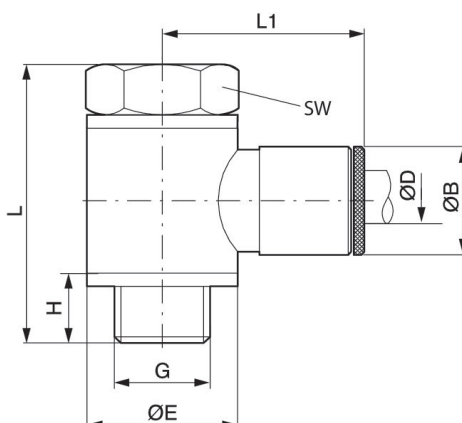

Part No.	Port D	Port G	L	L1	H	Ø B	Ø E	SW
1823391549	Ø 4	M5	17.5	18.5	4.5	9	7	8
1823391550	Ø 5	M5	17.5	19.5	4.5	10	7	8
1823391905	Ø 6	M5	19	19	4.5	10.5	10	8
1823391551	Ø 4	G 1/8	28	21	7.5	9	14	14
1823391552	Ø 5	G 1/8	28	22.5	7.5	10	14	14
1823391553	Ø 6	G 1/8	28	22.5	7.5	11	14	14
1823391554	Ø 8	G 1/8	28	24.5	7.5	13	14	14
1823391556	Ø 6	G 1/4	33	24	9	11	18	17
1823391557	Ø 8	G 1/4	33	26	9	13	18	17
1823391558	Ø 10	G 1/4	33	27	9	15	18	17
1823391559	Ø 8	G 3/8	36	28	9	13	21	19
1823391560	Ø 10	G 3/8	36	29	9	15	21	19
1823391561	Ø 12	G 3/8	36	30	9	17	21	19