

AVENTICS Multi-coupling

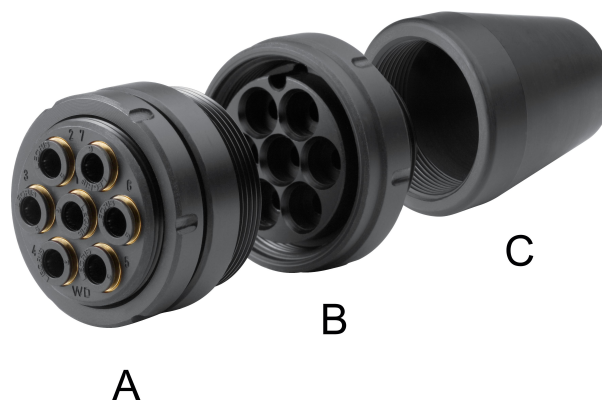

Technical data

Industry	Industrial
Number of ports	7
Application area	Suitable for bulkhead mounting
Tubing Ø	6 mm
Min. working pressure	0 bar
Max. working pressure	16 bar
Min. ambient temperature	-20 °C
Max. ambient temperature	80 °C
Min. medium temperature	-20 °C
Max. medium temperature	80 °C
Medium	Compressed air
Delivery unit	1 piece
Housing material	Polyamide R412007576

Technical information

Connect and release 4 to 7 compressed air hoses
Clear hose assembly with guide pins.

Protective cap

Fig. C

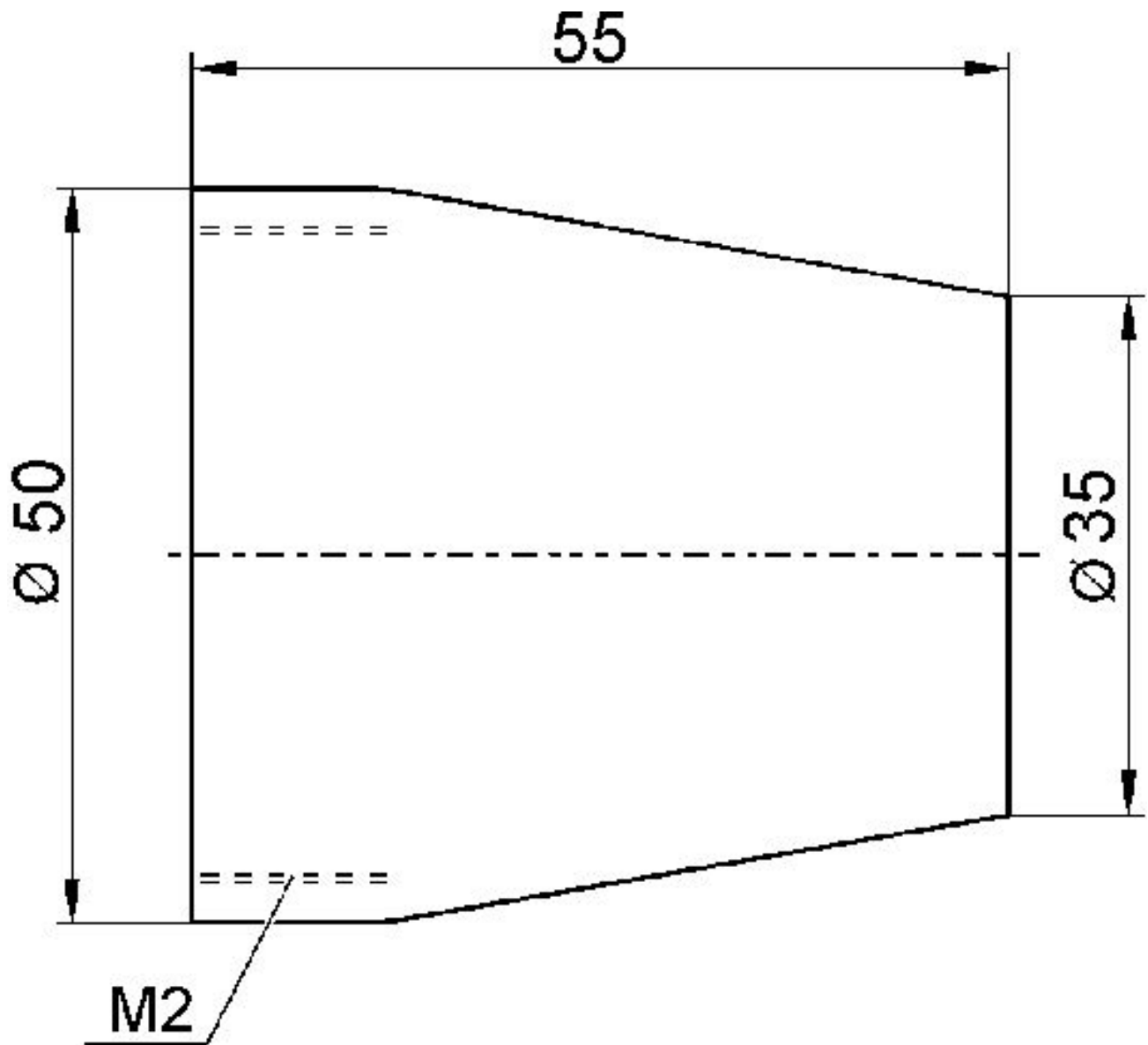

The protective cap can be assembled on both sides of the coupling.

Part No.	M2
R412007577	M40x1,5

Multi-coupling

R412007576

Multi-coupling

2024-05-17

coupling bushing

Fig. B

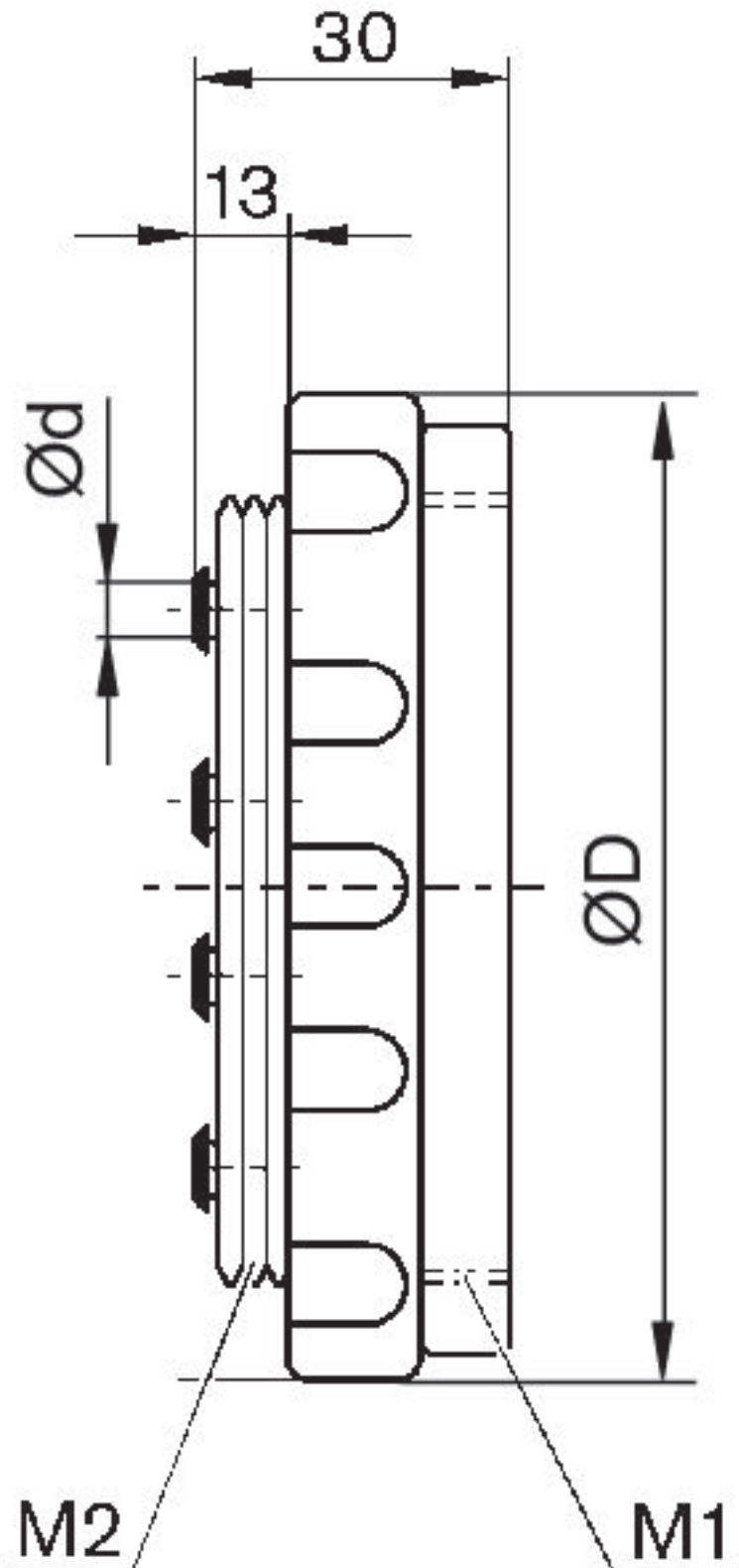

Multi-coupling

R412007576

Multi-coupling

2024-05-17

Part No.	M1	M2	Ød 1)	ØD
R412007570	M46x1,5	M40x1,5	4	55
R412007572	M46x1,5	M40x1,5	4	55
R412007574	M46x1,5	M40x1,5	6	55
R412007576	M46x1,5	M40x1,5	6	55

1) Tubing-Ø (external)

Coupling plug

Fig. A

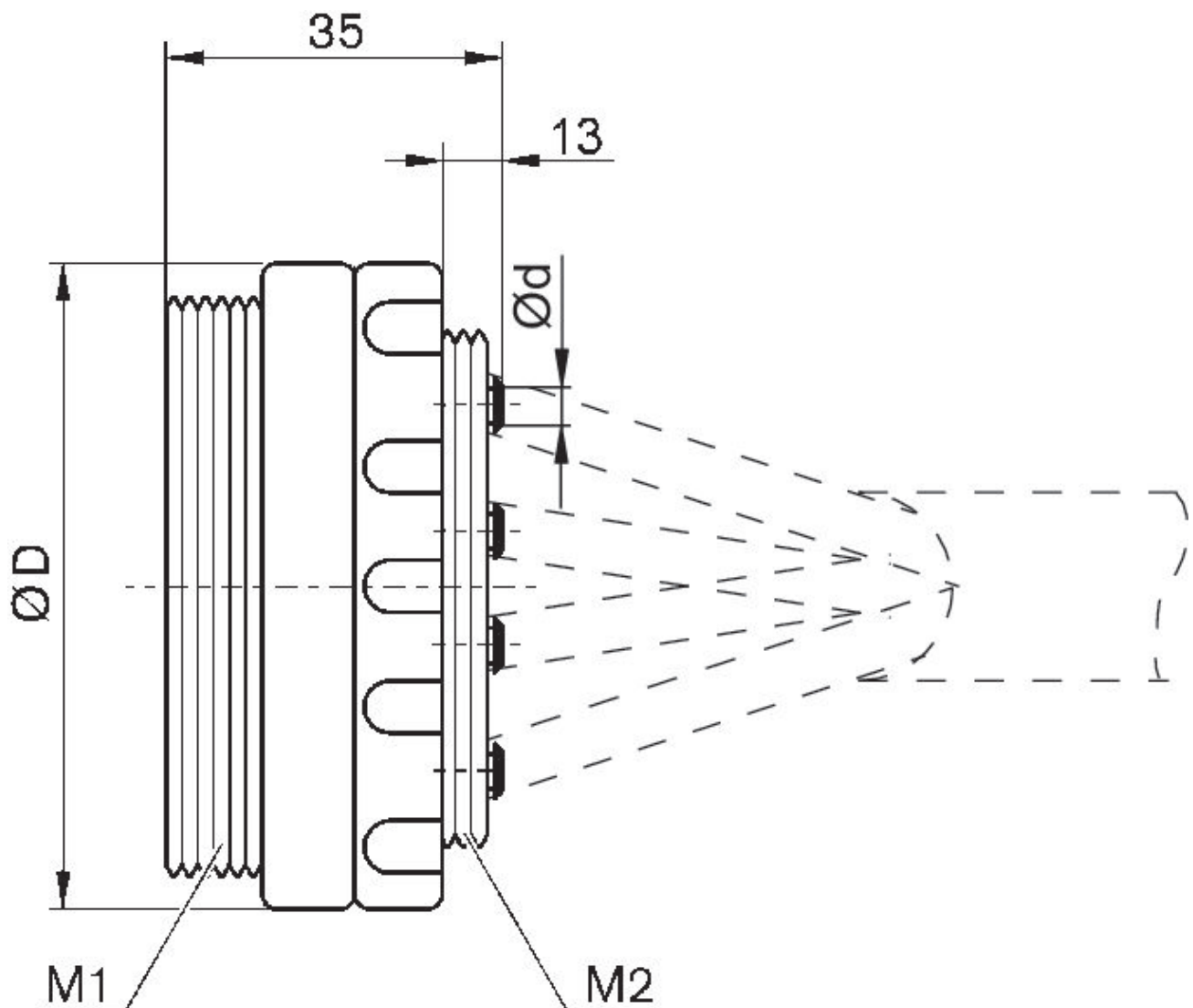

Multi-coupling

R412007576

Multi-coupling

2024-05-17

Part No.	M1	M2	Ød 1)	ØD
R412007569	M46x1,5	M40x1,5	4	50
R412007571	M46x1,5	M40x1,5	4	50
R412007573	M46x1,5	M40x1,5	6	50
R412007575	M46x1,5	M40x1,5	6	50

1) Tubing-Ø (external)