

# Bolts AA4, Series CM1

R412025613

CM1

2023-11-14

---

## Bolts



## Technical data

For series

RPC  
PRA  
TRB  
CCL-IS

Standardization

ISO 15552

Piston diameter

40 mm

## Material

Housing material

Stainless Steel

Part No.

R412025613

# Bolts AA4, Series CM1

R412025613

CM1

2023-11-14

## Dimensions

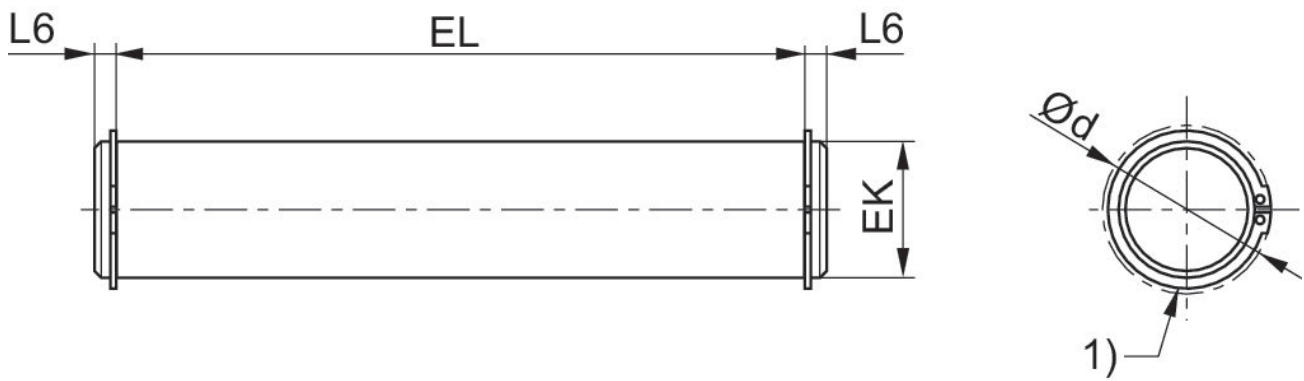

1) with circlip

Part No.	Piston Ø	Ø d max.	EK e8	EL +0.3	L6 max.
R412027660	25	9.6	10	36.5	3
R412025612	32	9.6	10	46	9
R412025613	40	11.5	12	53	9
R412025614	50	11.5	12	61	9
R412025615	63	15.2	16	71	11
R412025616	80	15.2	16	91	11
R412025617	100	19.0	20	111	11
R412025618	125	23.9	25	132	11