

AVENTICS Series BCR Bellow actuators

The AVENTICS Series BCR bellow cylinders are designed for applications that require very high forces with a mounting ring (no covers) and bellows made of natural rubber elastomer for direct mounting to suitable connection surfaces in the system. Therefore, the connection geometry is freely configurable.

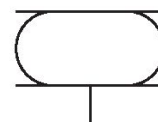

Technical data

Industry	Industrial
Bellows	single
Type	Bellow actuator with mounting ring
Functional principle	Single-acting, retracted without pressure
Cover diameter	638 mm
Max. permissible angle of tilt	20 °
Max. effective stroke	160.02 mm
Min. radial installation space	770 mm
Min. installation height	55.8 mm
Max. installation height	215.9 mm
Min. force	131000 N
Max. force	229000 N
Min. working pressure	0 bar
Max. working pressure	8 bar
Min. ambient temperature	-40 °C
Max. ambient temperature	70 °C
Medium	Compressed air
Reduced service life at a temperature greater than	50 °C
Pressure for determining forces	6 bar

R432039313

Weight 11.1 kg

Material

Material bellow	Natural rubber
Material mounting ring	Aluminum
Material clamping ring	Aluminum
Part No.	R432039313

Technical information

Compliance with the minimum height H_{min} . as well as the maximum height H_{max} . must be ensured with end stops.

Use at operating height $\geq H_{max}$: only permitted upon approval by AVENTICS

Further information on vibration isolation can be found in the “Technical information” document (available in the MediaCentre).

The pressure dew point must be at least 15 °C less than ambient and medium temperature and may not exceed 3 °C.

The oil content of compressed air must remain constant during the life cycle.

Use only the approved oils from AVENTICS. Further information can be found in the “Technical information” document (available in <https://www.emerson.com/en-us/support>).

Dimensions

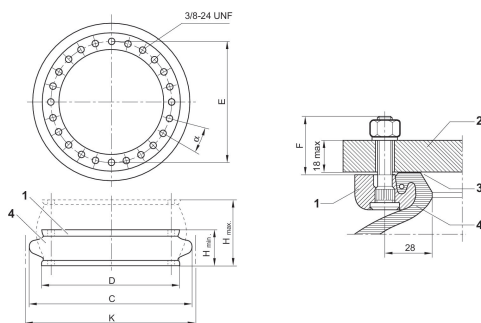

section of mounted bead ring with staybolt 1. mounting ring 2. machine part 3. sealing surface *) 4. bellow * recommendation for surface finish: if the surface is turned or cylindrically ground: Ra 6 if the surface is milled or surface ground: Ra 0,8 max torque: 30 lbf ft

Force-displacement diagram R432039315

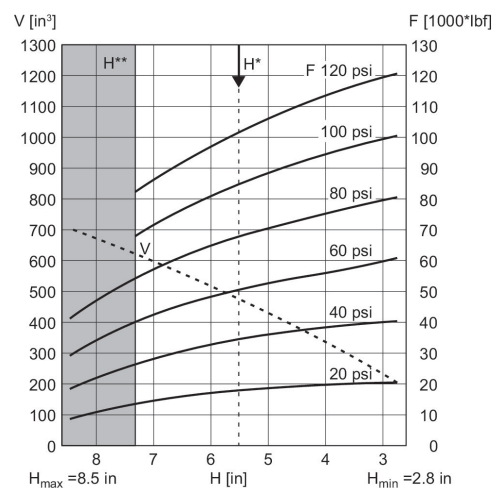

V = volume H = height H^* = recommended operating height for vibration isolation H^{**} = use permitted only upon approval by AVENTICS

R432039313

Force-displacement diagram
R432039313

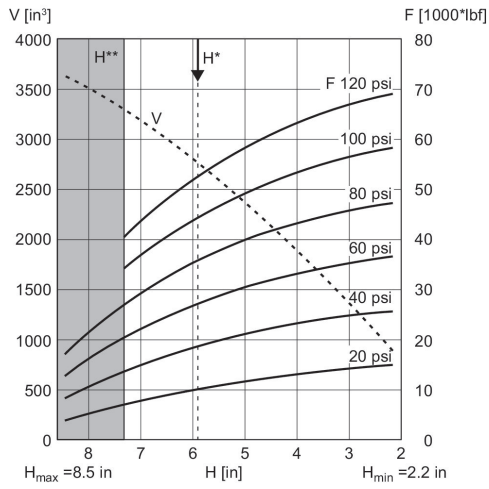

V = volume H = height H* = recommended operating height for vibration isolation H** = use permitted only upon approval by AVENTICS

Force-displacement diagram
R432039310

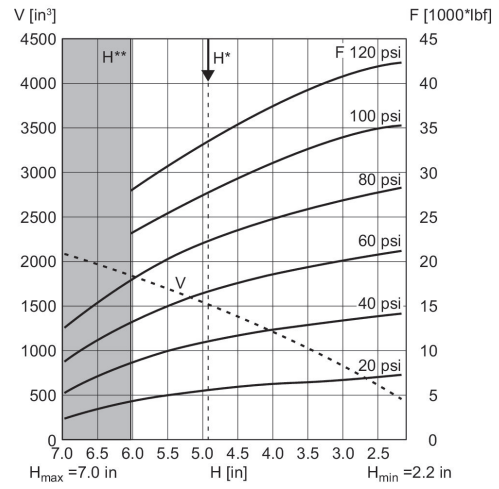

V = volume H = height H* = recommended operating height for vibration isolation H** = use permitted only upon approval by AVENTICS

Force-displacement diagram
R432039308

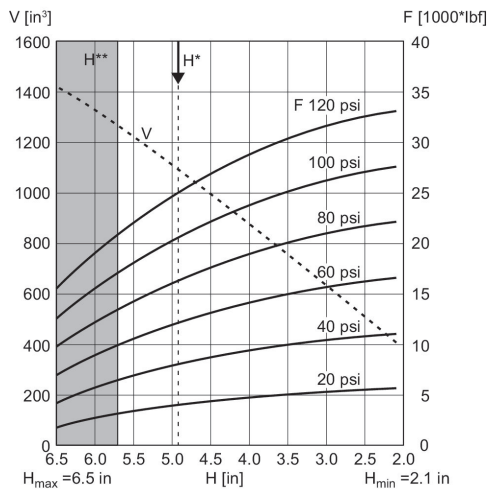

V = volume H = height H* = recommended operating height for vibration isolation H** = use permitted only upon approval by AVENTICS

Force-displacement diagram
R432039303

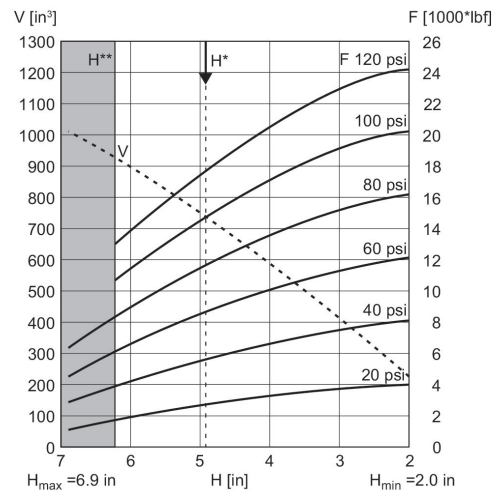

V = volume H = height H* = recommended operating height for vibration isolation H** = use permitted only upon approval by AVENTICS

Part No.	H min.	H max.	C	D	K	Min. re- turn force
R432039303	51	158	452	384	490	400
R432039308	53	145	530	451	570	90
R432039310	55	153	585	517	625	730
R432039313	55	186	725	638	770	670
R432039315	70	186	950	890	1000	1500