

Short-stroke cylinder, Series SSI, Double-acting, with magnetic piston, non-rotating

2024-09-13

R481653500

The AVENTICS Series SSI are short stroke cylinders in accordance with the latest ISO standard 15524. The cylinders are compact and up to 30% lighter than comparable cylinders thanks to weight optimized profiles. In addition, they provide a high degree of flexibility in sensor assembly and extremely effective elastic cushioning.

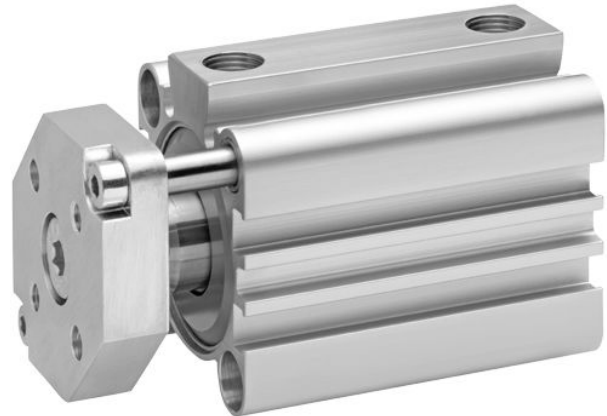

Technical data

Industry	Industrial
Standards	ISO 15524
Piston Ø	32 mm
Stroke	50 mm
Ports	1/8" NPTF
Functional principle	Double-acting
Cushioning	Elastic cushioning
Magnetic piston	Piston with magnet
Environmental requirements	Industry standard
Piston rod thread - type	Piston rod: internal thread
Piston rod	non-rotating, with front plate
Scraper	Standard Industry Scraper
Pressure for determining piston forces	6,3 bar
Retracting piston force	380 N
Extracting piston force	507 N
Min. ambient temperature	-20 °C
Max. ambient temperature	80 °C
Min. working pressure	0.6 bar
Max. working pressure	10 bar

Short-stroke cylinder, Series SSI, Double-acting, with magnetic piston, non-rotating

2024-09-13

R481653500	
Impact energy	0.16 J
Weight 0 mm stroke	0.216 kg
Weight +10 mm stroke	0.039 kg
Stroke max.	150 mm
Medium	Compressed air
Min. medium temperature	-20 °C
Max. medium temperature	80 °C
Max. particle size	50 µm
Min. oil content of compressed air	0 mg/m ³
Max. oil content of compressed air	5 mg/m ³

Material

Piston rod	Stainless Steel
Scraper material	Polyurethane
Seal material	Polyurethane
Material, front cover	Aluminum
Cylinder tube	Aluminum
End cover	Aluminum
Front plate	Aluminum
Guide rod	Stainless Steel
Part No.	R481653500

Technical information

The pressure dew point must be at least 15 °C less than ambient and medium temperature and may not exceed 3 °C.

The oil content of compressed air must remain constant during the life cycle.

Use only the approved oils from AVENTICS. Further information can be found in the "Technical information" document (available in <https://www.emerson.com/en-us/support>).

Short-stroke cylinder, Series SSI, Double-acting, with magnetic piston, non-rotating

2024-09-13

R481653500
Dimensions

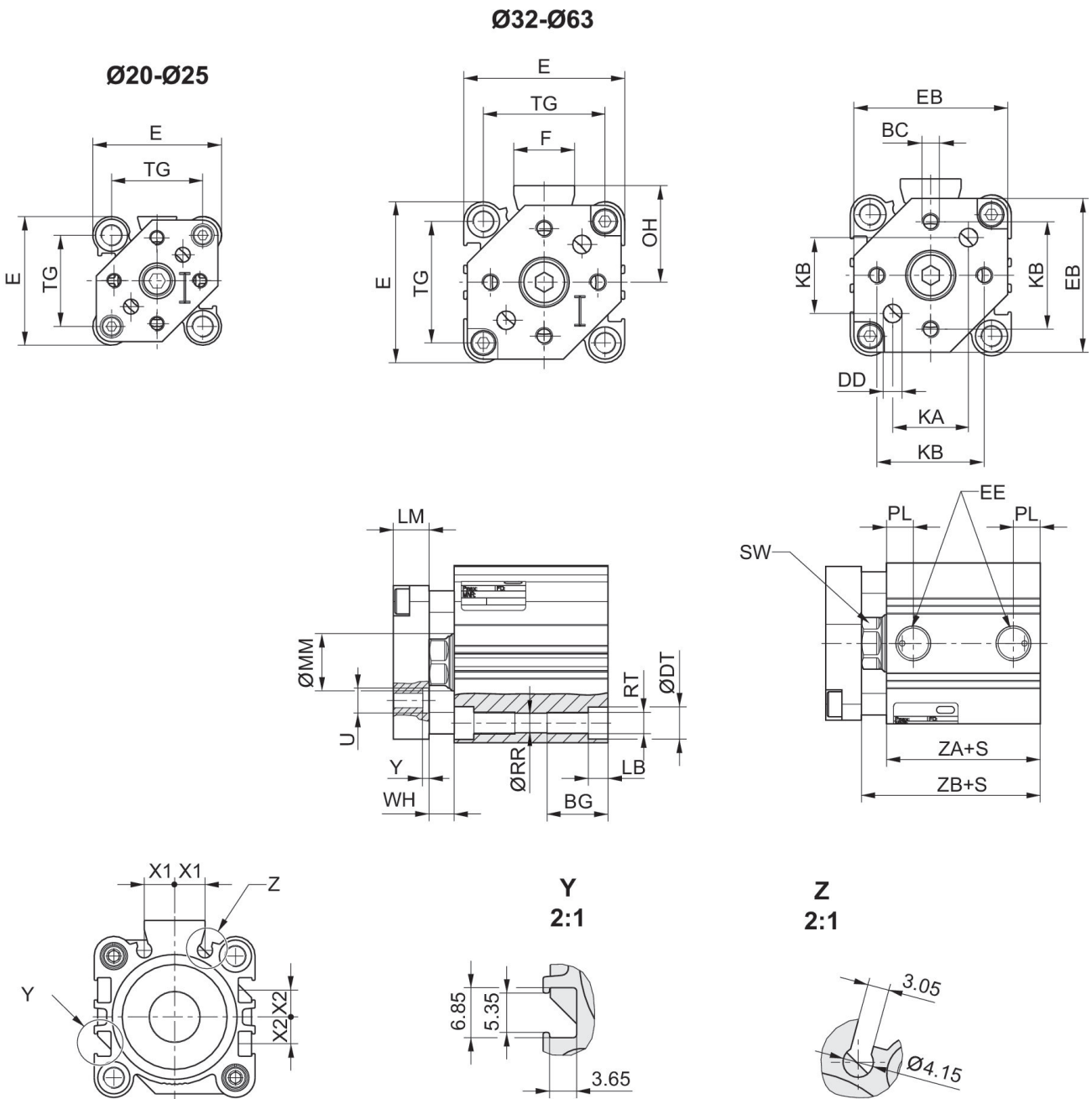

Piston Ø	BC	BG	ØDD H13	ØDT	E	EB	EE	F	FB
20	8-32 UNC	16	4,2	9	36	34	10-32 UNC	-	26
25	8-32 UNC	16	4,2	9	40	38	10-32 UNC	-	30
32	10-24 UNC	16	5,2	9	45	43	1/8" NPTF	17	38
40	1/4-20 UNC	16	6,1	9	52	50	1/8" NPTF	17	46
50	5/16-18 UNC	20	8,2	11	64	62	1/4" NPTF	21	58
63	7/16-14 UNC	25	11,5	14	77	74	1/4" NPTF	21	69

Short-stroke cylinder, Series SSI, Double-acting, with magnetic piston, non-rotating

2024-09-13

R481653500

Piston Ø	KA	KB	LB max.	LM	ØMM f8	OH	PL	ØRR	RT
20	14,5 ±0,1	24 ±0,1	5,5	8	10	-	5,5	5,55	10-24 UNC
25	16,3 ±0,1	28,5 ±0,1	5,5	8	12	-	5,5	5,55	10-24 UNC
32	21,2 ±0,2	30 ±0,2	5,5	10	16	27	7,9	5,55	10-24 UNC
40	24,7 ±0,2	35 ±0,2	5,5	10	16	31	8,2	5,55	10-24 UNC
50	32,2 ±0,2	45,5 ±0,2	8	12	20	39	10,5	7,4	5/16-24 UNF
63	35,7 ±0,2	50,8 ±0,2	10,5	12	20	45,5	10,6	9,3	7/16-14 UNC

Piston Ø	SW	TG	ØU H13	WH	X1	X2	Y	ZA±0,2	ZB±2
20	8	25,5 ±0,3	7,2	4,5 ±1,5	5,7	4,275	1,6	29,5	34
25	10	28 ±0,3	-	5 ±1,5	6	5	-	32,5	37,5
32	13	34 ±0,3	-	7 ±2	8,5	7,5	-	33	40
40	13	40 ±0,3	-	7 ±2	10,75	11	-	39,5	46,5
50	17	50 ±0,5	13,5	8 ±2	14	13	2,5	40,5	48,5
63	17	60 ±0,5	16,5	8 ±2	17	17	3,3	46	54

Max. permissible torque, Dynamic

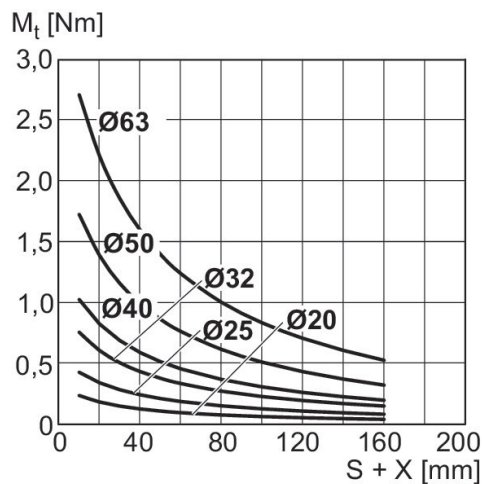

X = distance between force application point and cylinder cover
M = max. permissible torque
S = stroke

Maximum admissible lateral force dynamic

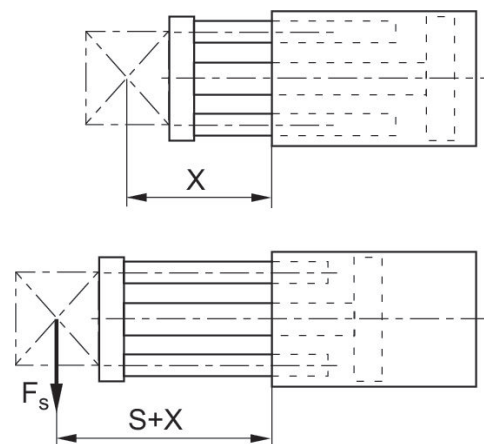

X = distance between force application point and cylinder cover
 F_s = lateral force
S = stroke

Short-stroke cylinder, Series SSI, Double-acting, with magnetic piston, non-rotating

2024-09-13

R481653500

Max. permissible torque, Dynamic

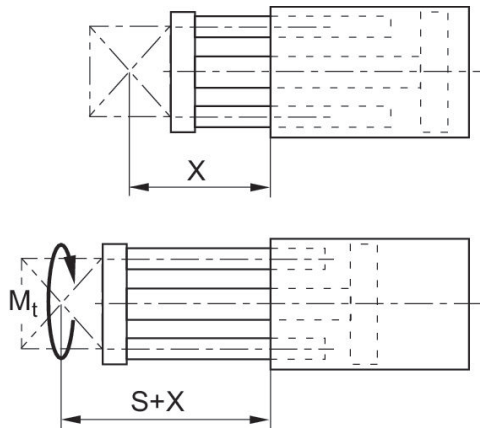

X = distance between force application point and cylinder cover
M = max. permissible torque
S = stroke

Maximum admissible lateral force dynamic

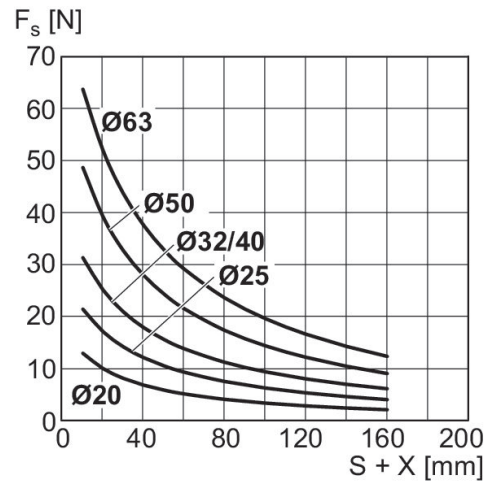

X = distance between force application point and cylinder cover
 F_s = lateral force
S = stroke

Short-stroke cylinder, Series SSI, Double-acting, with magnetic piston, non-rotating

2024-09-13

R481653500
Overview drawing



Use our Internet configurator to order variants with an external thread.

NOTE: This overview drawing is only for orientation to indicate where the various accessory parts can be fastened to the cylinder. The illustration has been simplified for this purpose. It is thus not possible to derive the dimensions from this overview.