

Short-stroke cylinder, Series SSI, single-acting, with magnetic piston

2024-09-13

R481653526

The AVENTICS Series SSI are short stroke cylinders in accordance with the latest ISO standard 15524. The cylinders are compact and up to 30% lighter than comparable cylinders thanks to weight optimized profiles. In addition, they provide a high degree of flexibility in sensor assembly and extremely effective elastic cushioning.



Technical data

Industry	Industrial
Standards	ISO 15524
Piston Ø	50 mm
Stroke	5 mm
Ports	1/4" NPTF
Functional principle	Single-acting, retracted without pressure
Cushioning	Elastic cushioning
Magnetic piston	Piston with magnet
Environmental requirements	Industry standard
Piston rod thread - type	Piston rod: internal thread
Piston rod thread	1/2-20 UNF
Piston rod	single
Scraper	Standard Industry Scraper
Pressure for determining piston forces	6,3 bar
Retracting piston force	39 N
Extracting piston force	1237 N
Min. ambient temperature	-20 °C
Max. ambient temperature	80 °C
Min. working pressure	1 bar

Short-stroke cylinder, Series SSI, single-acting, with magnetic piston

2024-09-13

R481653526

Max. working pressure 10 bar

Impact energy 0.32 J

Weight 0 mm stroke 0.385 kg

Weight +10 mm stroke 0.067 kg

Stroke max. 25 mm

Medium Compressed air

Min. medium temperature -20 °C

Max. medium temperature 80 °C

Max. particle size 50 µm

Min. oil content of compressed air 0 mg/m³

Max. oil content of compressed air 5 mg/m³

Material

Piston rod Stainless Steel

Seal material Polyurethane

Material, front cover Aluminum

Cylinder tube Aluminum

End cover Aluminum

Part No. R481653526

Technical information

Please note that this variant does not use a scraper.

For this variant with external thread, two different external threads with the dimensions indicated below can be selected in the configurator .

The pressure dew point must be at least 15 °C less than ambient and medium temperature and may not exceed 3 °C.

The oil content of compressed air must remain constant during the life cycle.

Use only the approved oils from AVENTICS. Further information can be found in the "Technical information" document (available in <https://www.emerson.com/en-us/support>).

Short-stroke cylinder, Series SSI, single-acting, with magnetic piston

2024-09-13

R481653526
Dimensions

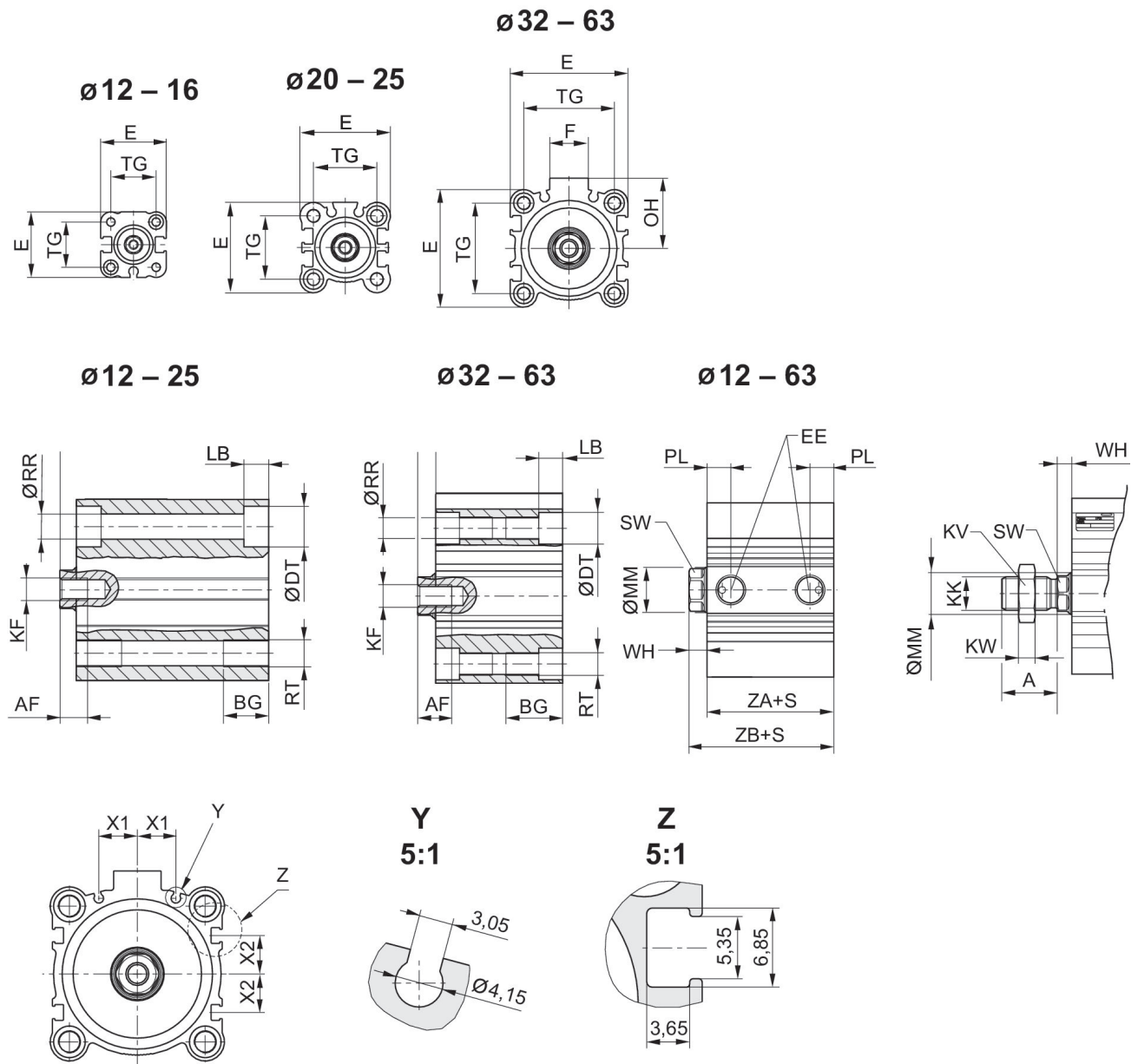

S = stroke

Piston Ø	A	AF	BG	ØDT	E	EE	F	KF	KK
12	10,5	6	7	6,5	25	10-32 UNF	-	6-32 UNC	8-32 UNC
16	12	8	7	6,5	29	10-32 UNF	-	8-32 UNC	8-32 UNC
20	14	7	10	9	36	10-32 UNF	-	10-32 UNF	10-32 UNF
25	17,5	12	10	9	40	10-32 UNF	-	1/4-28 UNF	1/4-28 UNF
32	21,5	13	16	9	45	1/8" NPTF	17	5/16-24 UNF	5/16-24 UNF
40	21,5	13	16	9	52	1/8" NPTF	17	3/8-24 UNF	3/8-24 UNF
50	26,5	15	20	11	64	1/4" NPTF	21	1/2-20 UNF	1/2-20 UNF
63	26,5	15	25	14	77	1/4" NPTF	21	1/2-20 UNF	1/2-20 UNF

Short-stroke cylinder, Series SSI, single-acting, with magnetic piston

2024-09-13

R481653526

Piston Ø	KV	KW	LB max.	ØMM f8	OH	PL	ØRR	RT	SW
12	8,7	2,8	3,5	6	-	5,5	3,7	8-32 UNC	5
16	8,7	2,8	3,5	8	-	5,5	3,7	8-32 UNC	7
20	9,5	2,8	5,5	10	-	5,5	5,55	1/4-24 UNC	8
25	11,1	4,1	5,5	12	-	5,5	5,55	1/4-24 UNC	10
32	12,7	4,9	5,5	16	27	7,9	5,55	1/4-24 UNC	13
40	14,2	5,7	5,5	16	31	8,2	5,55	1/4-24 UNC	13
50	19	8,2	8	20	39	10,5	7,4	5/16-24 UNC	17
63	19	8,2	10,5	20	45,5	10,6	9,3	7/16-14 UNC	17

Piston Ø	TG	WH 1)	WH 2)	X1	X2	ZA±0,2	ZB±2 1)	ZB±2 2)
12	15,5 ±0,3	3,5 ±1,5	3,5 ±1,5	0	0	28	31,5	31,5
16	20 ±0,3	3,5 ±1,5	3,5 ±1,5	0	0	30,5	34	34
20	25,5 ±0,3	4,5 ±1,5	4,5 ±1,5	5,7	4,275	31,5 3)	36 3)	36 3)
25	28 ±0,3	5 ±1,5	5 ±1,5	6	5	32,5 3)	37,5 3)	37,5 3)
32	34 ±0,3	7 ±2	7 ±2	8,5	7,5	33	40	40
40	40 ±0,3	7 ±2	7 ±2	10,75	11	39,5	46,5	46,5
50	50 ±0,5	8 ±2	7 ±2	14	13	40,5	48,5	47,5
63	60 ±0,5	8 ±2	7 ±2	17	17	46	54	53

1) Internal thread
2) External thread

3) For stroke 11-25 mm + 6.5 mm

Retracting piston force

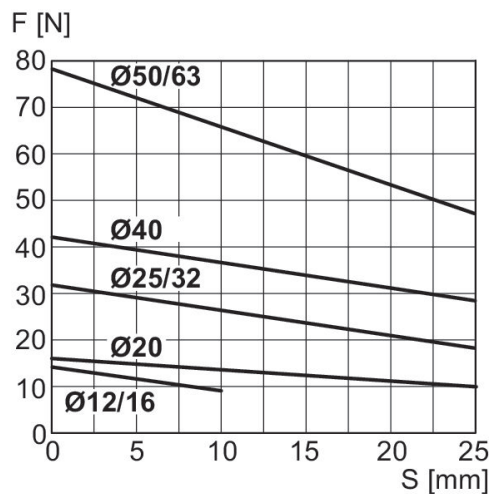

F = spring return force, s = return stroke

Maximum admissible lateral force Ø 12 ... 25 mm

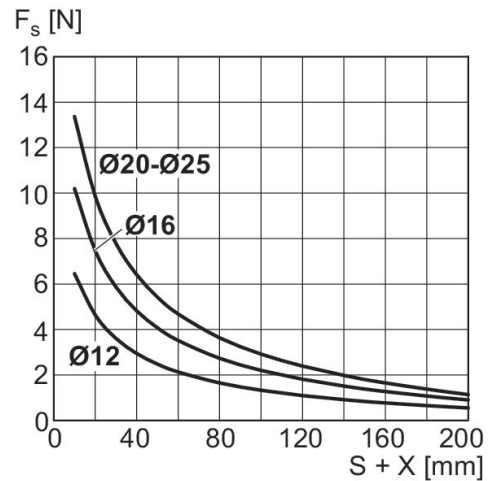

X = distance between force application point and cylinder cover
FS = lateral force
S = stroke

Short-stroke cylinder, Series SSI, single-acting, with magnetic piston

2024-09-13

R481653526

Maximum admissible lateral force

Ø 32 ... 63 mm

Maximum admissible lateral force

Ø 12 ... 25 mm

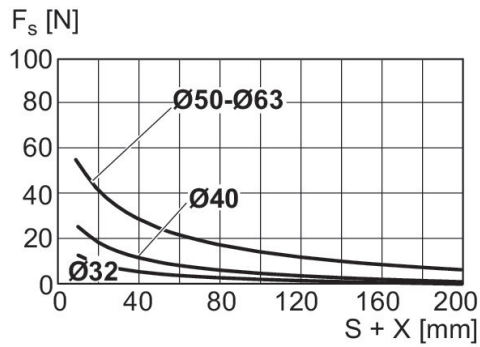

X = distance between force application point and cylinder cover
 FS = lateral force
 S = stroke

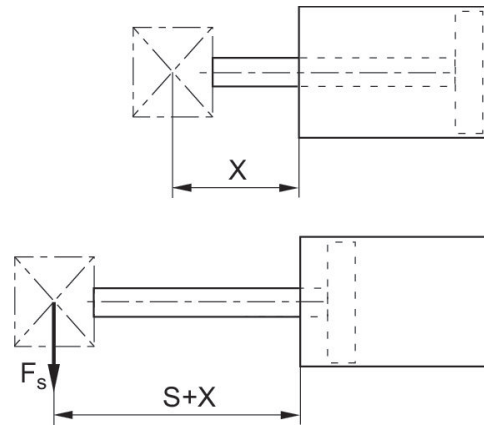

X = distance between force application point and cylinder cover
 FS = lateral force
 S = stroke

Short-stroke cylinder, Series SSI, single-acting, with magnetic piston

2024-09-13

R481653526
Overview drawing



Use our Internet configurator to order variants with an external thread.

NOTE: This overview drawing is only for orientation to indicate where the various accessory parts can be fastened to the cylinder. The illustration has been simplified for this purpose. It is thus not possible to derive the dimensions from this overview.