

Short-stroke cylinder, Series SSI, double-acting, without magnetic piston

2024-09-13

R481653569

The AVENTICS Series SSI are short stroke cylinders in accordance with the latest ISO standard 15524. The cylinders are compact and up to 30% lighter than comparable cylinders thanks to weight optimized profiles. In addition, they provide a high degree of flexibility in sensor assembly and extremely effective elastic cushioning.

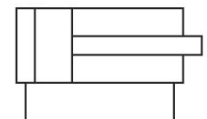

Technical data

Industry	Industrial
Standards	ISO 15524
Piston Ø	100 mm
Stroke	30 mm
Ports	3/8" NPTF
Functional principle	Double-acting
Cushioning	Elastic cushioning
Magnetic piston	Piston without magnet
Environmental requirements	Industry standard
Piston rod thread - type	Piston rod: internal thread
Piston rod thread	3/4-16 UNF
Piston rod	single
Scraper	Standard Industry Scraper
Pressure for determining piston forces	6,3 bar
Retracting piston force	4441 N
Extracting piston force	4948 N
Min. ambient temperature	-20 °C
Max. ambient temperature	80 °C
Min. working pressure	0.6 bar

Short-stroke cylinder, Series SSI, double-acting, without magnetic piston

2024-09-13

R481653569

Max. working pressure 10 bar

Impact energy 0.5 J

Weight 0 mm stroke 1.83 kg

Weight +10 mm stroke 0.168 kg

Stroke max. 150 mm

Medium Compressed air

Min. medium temperature -20 °C

Max. medium temperature 80 °C

Max. particle size 50 µm

Min. oil content of compressed air 0 mg/m³

Max. oil content of compressed air 5 mg/m³

Material

Piston rod	Stainless Steel
Scraper material	Polyurethane
Seal material	Nitrile butadiene rubber
Material, front cover	Aluminum
Cylinder tube	Aluminum
End cover	Aluminum
Part No.	R481653569

Technical information

For this variant with external thread, two different external threads with the dimensions indicated below can be selected in the configurator .

Note the selection of fittings for strokes < 10 mm.

The pressure dew point must be at least 15 °C less than ambient and medium temperature and may not exceed 3 °C.

The oil content of compressed air must remain constant during the life cycle.

Use only the approved oils from AVENTICS. Further information can be found in the "Technical information" document (available in <https://www.emerson.com/en-us/support>).

Short-stroke cylinder, Series SSI, double-acting, without magnetic piston

2024-09-13

R481653569
Dimensions

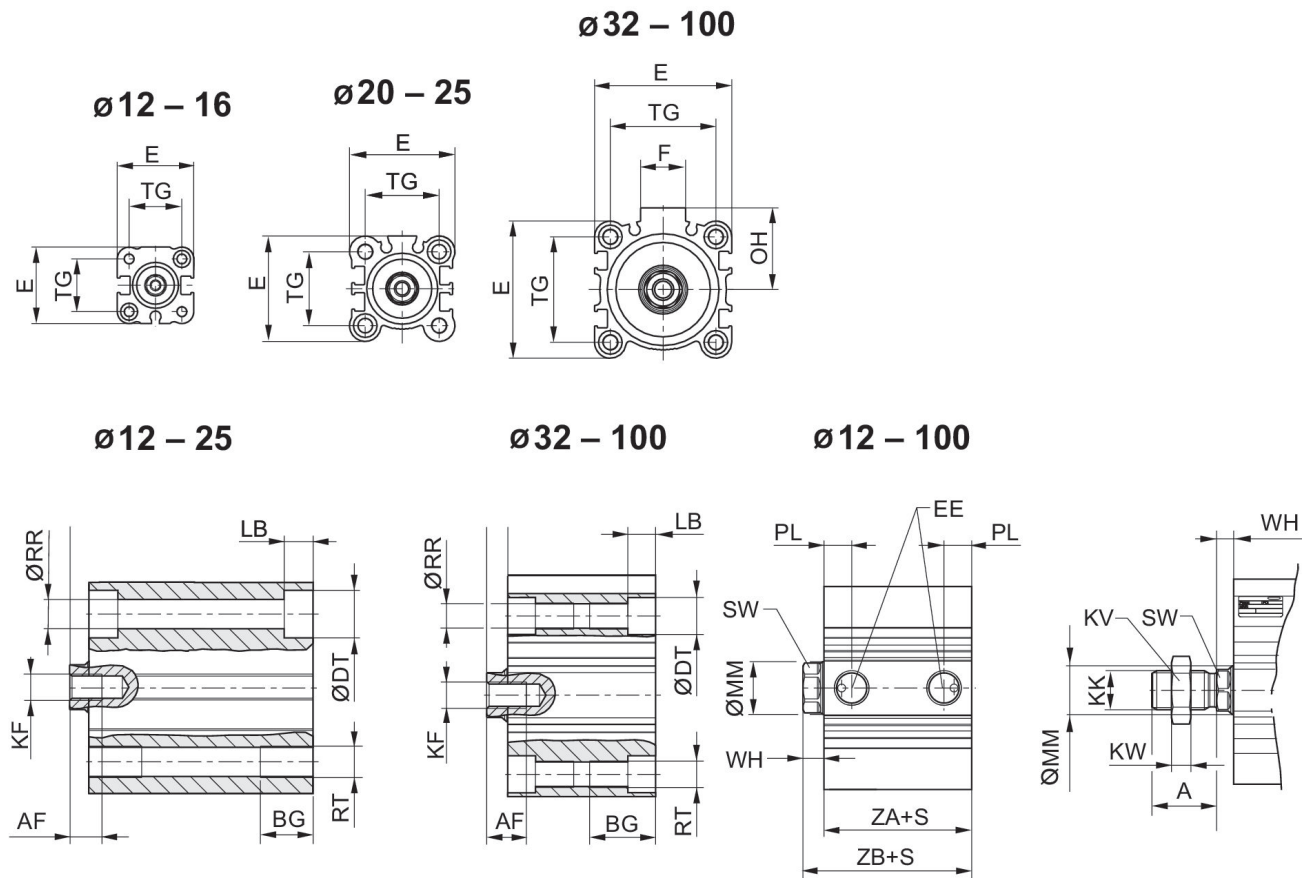

S = stroke

Short-stroke cylinder, Series SSI, double-acting, without magnetic piston

2024-09-13

R481653569

Maximum admissible lateral force
 Ø 32 ... 100 mm

Maximum admissible lateral force
 Ø 12 ... 25 mm

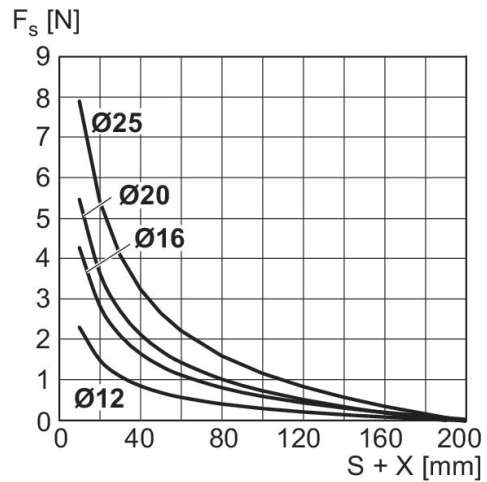
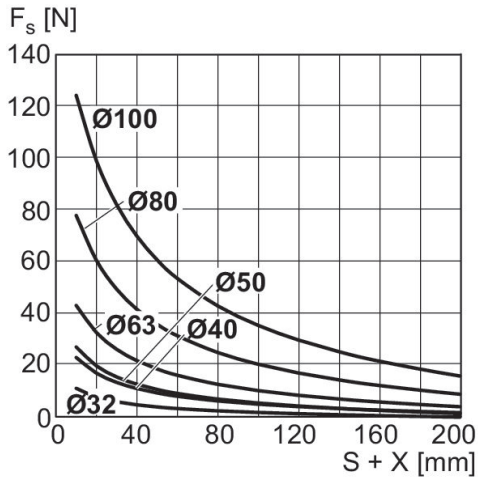

X = distance between force application point and cylinder cover
 FS = lateral force
 S = stroke

X = distance between force application point and cylinder cover
 FS = lateral force
 S = stroke

Maximum admissible lateral force
 Ø 12 ... 25 mm

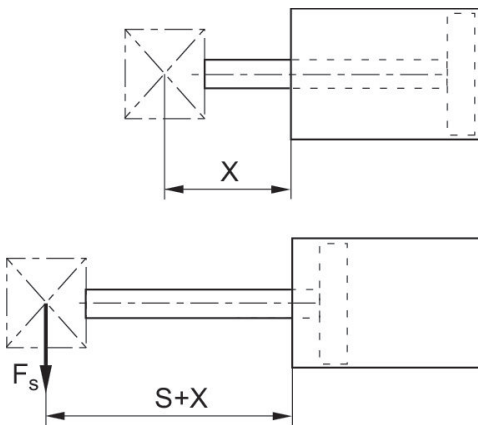

X = distance between force application point and cylinder cover
 FS = lateral force
 S = stroke

Short-stroke cylinder, Series SSI, double-acting, without magnetic piston

2024-09-13

R481653569
Overview drawing

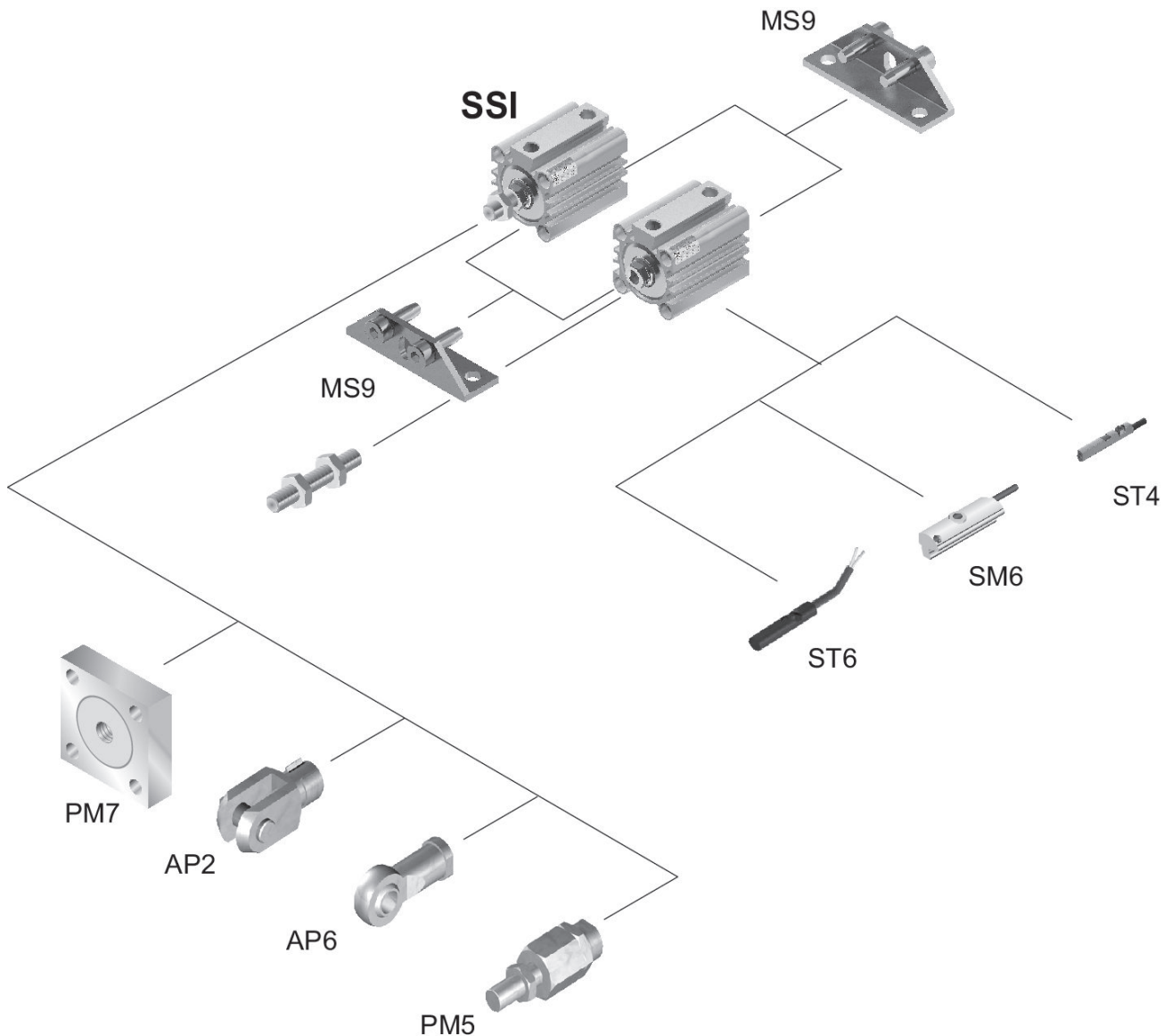

Use our Internet configurator to order variants with an external thread.

NOTE: This overview drawing is only for orientation to indicate where the various accessory parts can be fastened to the cylinder. The illustration has been simplified for this purpose. It is thus not possible to derive the dimensions from this overview.

Piston Ø	A ±0.3	AF	BG	ØDT	E	EE	F	KF	KK
12	10,5	6	7	6,5	25	10-32 UNF	-	6-32 UNC	8-32 UNC
16	12	8	7	6,5	29	10-32 UNF	-	8-32 UNC	8-32 UNC
20	14	7	10	9	36	10-32 UNF	-	10-32 UNF	10-32 UNC
25	17,5	12	10	9	40	10-32 UNF	-	1/4-28 UNF	1/4-28 UNF
32	21,5	13	16	9	45	1/8" NPTF 1)	17	5/16-24 UNF	5/16-24 UNF
40	21,5	13	16	9	52	1/8" NPTF	17	3/8-24 UNF	3/8-24 UNF
50	26,5	15	20	11	64	1/4" NPTF 2)	21	1/2-20 UNF	1/2-20 UNF

Short-stroke cylinder, Series SSI, double-acting, without magnetic piston

2024-09-13

R481653569

Piston Ø	A ±0.3	AF	BG	ØDT	E	EE	F	KF	KK
63	26,5	15	25	14	77	1/4" NPTF	21	1/2-20 UNF	1/2-20 UNF
80	34	21	30	17,5	98	3/8" NPTF	26	5/8-18 UNF	5/8-18 UNF
100	33	27	30	17,5	117	3/8" NPTF	26	3/4-16 UNF	3/4-16 UNF

Piston Ø	KV	KW	LB max.	ØMM f8	OH	ØRR	RT	SW	TG
12	8,7	2,8	3,5	6	-	3,7	8-32 UNC	5	15,5 ±0,3
16	8,7	2,8	3,5	8	-	3,7	8-32 UNC	7	20 ±0,3
20	9,5	2,8	5,5	10	-	5,55	1/4-20 UNC	8	25,5 ±0,3
25	11,1	4,1	5,5	12	-	5,55	1/4-20 UNC	10	28 ±0,3
32	12,7	4,9	5,5	16	27	5,55	1/4-20 UNC	13	34 ±0,3
40	14,2	5,7	5,5	16	31	5,55	1/4-20 UNC	13	40 ±0,3
50	19	8,2	8	20	39	7,4	5/16-24 UNF	17	50 ±0,5
63	19	8,2	10,5	20	45,5	9,3	7/16-14 UNC	17	60 ±0,5
80	23,9	9,8	13,5	25	59	11,2	1/2-13 UNC	22	77 ±0,5
100	28,4	11,3	13,5	32	65	11,2	1/2-13 UNC	27	94 ±0,5

Piston Ø	WH 3)	WH 4)	X1	X2	S	PL	ZA±0,2	ZB±2	ZB±2 1)
12	3,5 ±1,5	3,5 ±1,5	0	0	2-4	4,5	17	20,5	20,5
					≥5	5,5			
16	3,5 ±1,5	3,5 ±1,5	0	0	≥2	5,5	18,5	22	22
20	4,5 ±1,5	4,5 ±1,5	5,7	4,275	≥2	5,5	19,5	24	24
25	5 ±1,5	5 ±1,5	6	5	≥2	5,5	22,5	27,5	27,5
32	7 ±2	7 ±2	8,5	7,5	2-5	5,5	23	30	30
					≥6	7,9			
40	7 ±2	7 ±2	10,75	11	≥2	8,2	29,5	36,5	36,5
50	8 ±2	7 ±2	14	13	2-9	8,2	30,5	38,5	37,5
					≥10	10,5			
63	8 ±2	7 ±2	17	17	≥2	10,6	36	44	43
80	10 ±2	9,5 ±2	23,5	21	≥2	12,5	43,5	53,5	53
100	12 ±2,5	10,5 ±2,5	31	28	≥2	14	53	65	63,5

1) For stroke 2-5, EE = 10-32 UNF

2) For stroke 2-9, EE = 1/8 NPTF

3) Internal thread

4) External thread